

*TOPAZ™ Desktop Magnifier*  
User's Guide

Freedom Scientific Blind/Low Vision Group, LLC  
March 2007

Part #440308-001 Revision H

PUBLISHED BY  
Freedom Scientific  
11800 31<sup>st</sup> Court North  
St. Petersburg, Florida 33716-1805  
USA  
<http://www.FreedomScientific.com>

Information in this document is subject to change without notice. No part of this publication may be reproduced or transmitted in any form or by any means electronic or mechanical, for any purpose, without the express written permission of Freedom Scientific.

© 2007 Freedom Scientific Blind/Low Vision Group, LLC. All Rights Reserved.

TOPAZ™ is a trademark of Freedom Scientific Blind/Low Vision Group, LLC in the United States and other countries.

## Federal Communications Commission Notice

This equipment has been tested and found to comply with the limits for a Class B digital device, pursuant to Part 15 of the FCC Rules. These limits are designed to provide reasonable protection against harmful interference in a residential installation. This equipment generates, uses, and can radiate radio frequency energy and, if not installed and used in accordance with the instructions, may cause harmful interference to radio communications. However, there is no guarantee that interference will not occur in a particular installation. If this equipment does cause harmful interference to radio or television reception, which can be determined by turning the equipment off and on, the user is encouraged to try to correct the interference by one or more of the following measures:

- Increase the separation between the equipment and receiver.
- Connect the equipment into an outlet on a circuit different from that to which the receiver is connected.
- Reorient or relocate the receiving antenna.
- Consult the dealer or an experienced radio or television technician for help.

**Note:** Unit has been designed for connection to an IT power distribution system.

# Table of Contents

<b>Overview .....</b>	<b>1</b>
TOPAZ Models .....	3
TOPAZ Components.....	4
What's in the Box .....	6
Safety and Maintenance .....	6
<b>Getting Started .....</b>	<b>8</b>
Assembling TOPAZ .....	8
Connecting the Video Cable .....	8
Connecting the Power Cables .....	9
<b>Quick Start Tutorial.....</b>	<b>11</b>
<b>Using the TOPAZ Camera Controls .....</b>	<b>14</b>
Brightness Button (Yellow).....	14
Focus Lock Button (Orange).....	15
Magnification Dial.....	15
Position Locator Button (Red).....	16
Video Mode Button (Blue).....	16
Power Button (Green) .....	16
<b>Reading with TOPAZ .....</b>	<b>17</b>
Adjusting the Picture .....	18
Changing the Brightness.....	19
Changing the Video Mode .....	19
Using the Reading Table .....	20

Adjusting the LCD Flat Panel Monitor .....	22
<b>Writing or Doing Crafts with TOPAZ .....</b>	<b>23</b>
<b>Viewing Photos and Other Glossy Items.....</b>	<b>24</b>
<b>Connecting TOPAZ to a Television .....</b>	<b>25</b>
<b>Service and Support.....</b>	<b>26</b>
Troubleshooting .....	27
<b>Appendix: Advanced Video Controls.....</b>	<b>31</b>
Choosing Custom Video Modes .....	32
Changing the Brightness and Contrast for Custom Video Modes .....	34
Changing the Color and Tint.....	36
Hiding the Zoom Position Display .....	38
Hiding the Focus Lock Display.....	39
Reset Factory Default .....	40
Minimal Video Mode Configuration .....	40



The TOPAZ™ Desktop Video Magnifier makes seeing printed type, pictures, handwriting, and small details easier than ever before. Just place a letter or picture on the moveable reading table, and adjust the magnification level and the display colors to work best for your eyesight. Your document displays in large size on the screen.

Developed by Freedom Scientific – the world’s leader in technology solutions for those with visual impairments – the TOPAZ has been designed with special attention to the vision needs of those with macular degeneration, glaucoma, retinitis pigmentosa, cataracts, and other causes of low vision.

The TOPAZ includes the following features:

- Auto Focus creates the clearest view without any need to make adjustments.
- Adjust pre-set video modes for high contrast text that is most comfortable for your individual eyesight.
- Increase or decrease brightness.
- Use the Position Locator beam to mark the center of the image for easy document placement and writing.
- 16 magnification levels with a crisp, sharp image let you precisely adjust text to the size you need.

- Lock the focus onto an object you want to see when writing or doing crafts. The camera stays focused on the object and not your hand.
- Two lights on either side of the camera provide object illumination, which is diffused to prevent glare and reflections when viewing shiny documents like magazines and photos.
- The large low-friction reading table moves a full 16 inches from left to right for easy reading of even large-format documents.
- The reading table's braking mechanism lets you lock the table movement down tight when you want it to hold steady.
- Models with LCD flat panel displays allow you to adjust the height and angle of the screen for the best view and for more neck and upper back comfort when viewing.

The forward-mounted camera is high above the table, so you have plenty of room to work, write, and do projects like tightening the tiny screws on your eyeglass frames, threading needles, and hand sewing. With TOPAZ's magnification features, you'll be able to read:

- Small print in contracts
- Numbers in the phone book
- Instructions on prescription bottles
- Labels from products of all sizes and shapes

- Crossword puzzles
- Controls on portable telephones and remote controls
- Newspaper and TV program listings
- And much more

TOPAZ is at home anywhere – in the office, classroom, libraries and reading rooms, living room, workshop – even the kitchen! It uses just one wall plug. Depend on it to magnify small parts for hobbies, small repairs, even the smallest print in manuals, recipe books, legal documents, spreadsheets, textbooks, homework, and tests.

## **TOPAZ Models**

The TOPAZ is available in six different models:

- The base TOPAZ model includes just the magnifying camera, monitor stand, and reading table. You must supply your own monitor to see magnified images.
- Two models that include everything in the basic model, plus a 15-inch or 17-inch standard CRT monitor.
- Two models that include everything in the basic model, in addition to a space-saving, no-glare, adjustable 17-inch, 19-inch, or 21-inch LCD flat panel monitor.

# TOPAZ Components

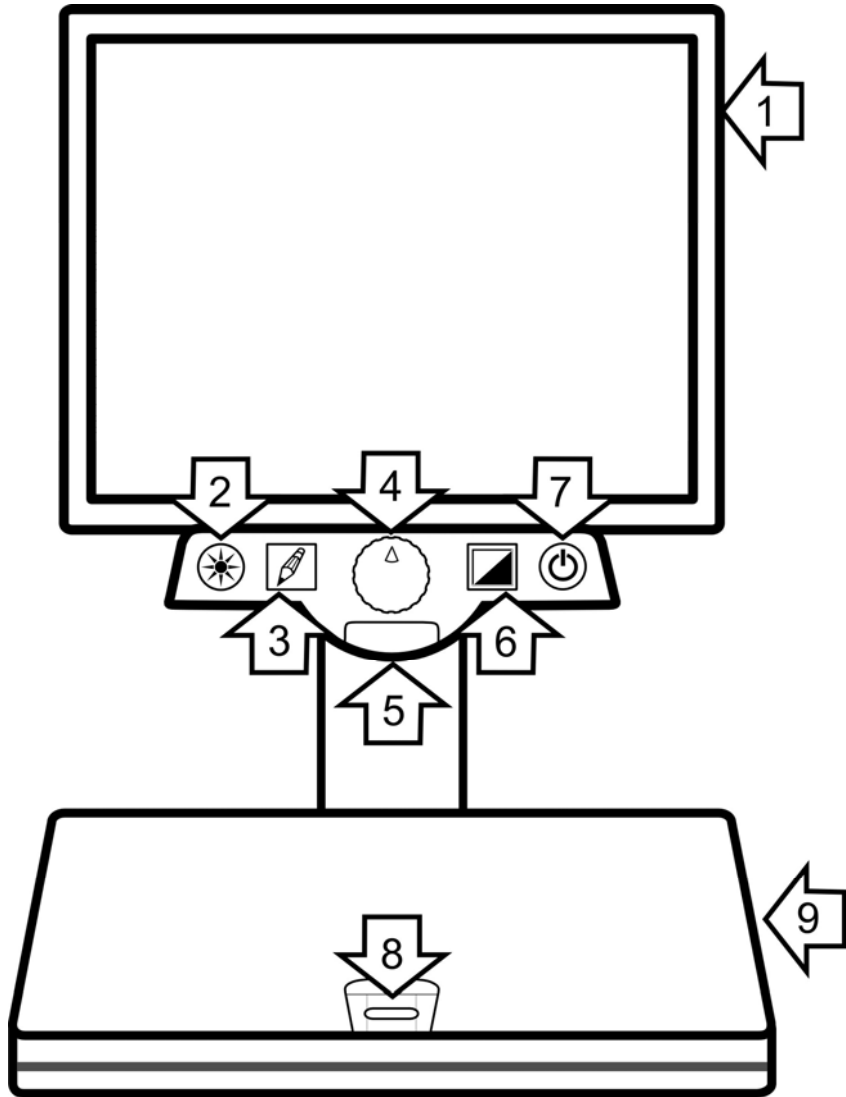

*TOPAZ Front View  
(see key on next page)*

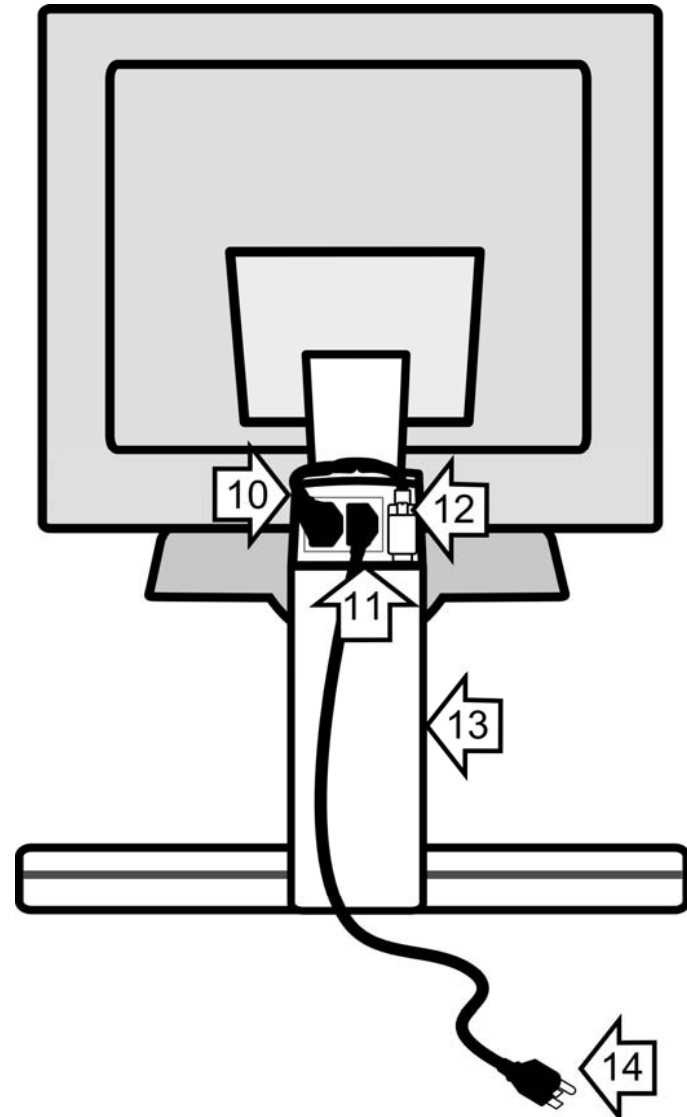

*TOPAZ Back View  
(see key on next page)*

## **TOPAZ Components (continued)**

- 1▶ Monitor**
- 2▶ Brightness Button**
- 3▶ Focus Lock Button**
- 4▶ Magnification Dial**
- 5▶ Position Locator Button**
- 6▶ Video Mode Button**
- 7▶ Power Button**
- 8▶ Table Lock Slider**
- 9▶ Reading Table**
- 10▶ Monitor Power Port**
- 11▶ TOPAZ Power Port (to wall outlet)**
- 12▶ Monitor Video Port**
- 13▶ Monitor Stand**
- 14▶ TOPAZ Power Cable**

## What's in the Box

Before using TOPAZ, take out all the items that are included in the box. Identify and set aside each component. The following items are included with TOPAZ:

- TOPAZ
- TOPAZ power cable
- TOPAZ user's guide
- Monitor and power cable (CRT and LCD models only)
- TV connector cable (only included with the camera-only TOPAZ model)

## Safety and Maintenance

To keep TOPAZ in good condition and to ensure safe usage, observe the following guidelines:

- Read the instructions in this user's guide before attempting to use TOPAZ.
- Do not attempt to repair the unit or open its case. This product contains no user serviceable parts.
- Keep the unit away from wet areas, rain, and other sources of liquids or high humidity. Do not submerge the unit.

- Always operate TOPAZ in a place where the temperature is between 10° and 40° C (50° and 104° F).
- Always store TOPAZ in a place where the temperature is between -20° and 65° C (-4° and 149° F). Do not store in a parked car, because the temperature often exceeds this range.
- Always use and store TOPAZ on a stable, level, hard surface such as a desk or table.
- When carrying or transporting TOPAZ, it is recommended that you move the CRT monitor separately.
- Do not attempt to force any connector into the unit's ports. All appropriate connectors should fit easily into the ports. If the connector does not fit, turn it around, and try again.
- Use only the power cable that came with your TOPAZ. Other adapters may damage the unit.
- When cleaning TOPAZ, make sure the unit is unplugged. To clean TOPAZ, lightly dampen a soft, clean cloth with water or mild detergent. When cleaning the screen, use a special screen cleaning tissue or solution suitable for the antistatic coating if possible.

## Assembling TOPAZ

All of the TOPAZ components are shipped pre-assembled. All you need to do is connect the video and power cables. Before beginning the assembly, place the TOPAZ base on a sturdy and stable work surface, such as a desk or table. Ensure that there is enough room on the table to allow you to move the reading table from side to side.

### Connecting the Video Cable

The basic TOPAZ model does not include a monitor, so you must supply one yourself. Other TOPAZ models include a CRT or LCD monitor.

To set up the TOPAZ CRT model, place the monitor on the platform located on the top of the unit. Make sure that the monitor is securely positioned on the center of the platform so that it does not fall or slide off. If you are supplying your own monitor, place the monitor on a stable surface next to TOPAZ in such a way that it will be easy and comfortable to view during use. The monitor for TOPAZ LCD model is already attached to the unit.

Do the following to connect the monitor's video cable to the TOPAZ:

1. Locate the video cable attached to the back of the monitor. If you have an LCD monitor, you must connect the video cable to the back of the monitor. Find the rectangular, multi-pronged connector with two screws at the end of this cable.

2. Plug the video cable into the video port on the back of the TOPAZ monitor stand.

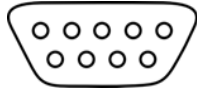

*Monitor video port.*

3. Hand-tighten the two screws on the video cable connector to secure the cable in place.

## **Connecting the Power Cables**

After you attach the monitor and connect the video cable, do the following to connect the monitor and TOPAZ power cables:

1. Locate the power cable for the monitor and the TOPAZ power cable.
2. Plug the female end of the monitor power cable into the three pronged plug on the back of the monitor. If you have a model with an LCD monitor, skip this step.
3. Plug the other end of the monitor's power cable into one of the ports with three openings located in the back of the TOPAZ monitor stand.

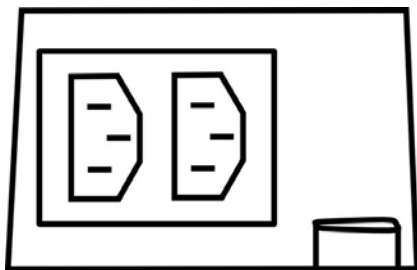

*TOPAZ power ports.*

4. Plug the female end of the TOPAZ power cable into the other port with three prongs, next to where you plugged in the monitor.
5. Plug the other end of the TOPAZ power cable into an available wall outlet. TOPAZ will turn on automatically when you plug it in.
6. Turn on the power to the monitor. If you purchased a TOPAZ model that includes a monitor, locate the row of buttons along the bottom of the screen. Press the one furthest to the right (this is the monitor's power button). A light turns on to indicate that the monitor has power.

**Note:** You do not need to turn off the monitor when you are finished using TOPAZ. The monitor automatically enters sleep mode when you turn off TOPAZ.

## Quick Start Tutorial

This tutorial will get you started using TOPAZ quickly. Before beginning, ensure you have followed the assembly instructions and that the unit is plugged into a wall outlet.

1. Press the green **POWER** button  to turn on the unit. This button is located on the right side of the TOPAZ control panel.
2. Place this book onto the center of the reading table. Notice how this page of the guide displays on the monitor.





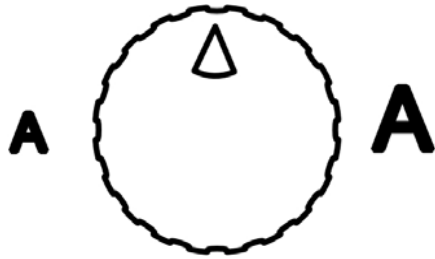

*Reading table.*

3. Locate the **MAGNIFICATION** dial in the center of the TOPAZ control panel. Turn the dial to the right to increase the magnification level. Then, turn the dial to the left to decrease the magnification. Find a magnification level that lets you read comfortably while seeing as much of the text as possible.



*Magnification dial.*

4. Press the blue **VIDEO MODE** button  located to the right of the **MAGNIFICATION** dial. Notice how the screen changes to a different color combination. Keep pressing the **VIDEO MODE** button  to cycle through the different color modes. Find the mode that best suits your vision needs.
5. Press and hold the yellow **BRIGHTNESS** button  to the left of the **MAGNIFICATION** dial to increase the brightness of the screen. Then, release the button. Press and hold it down again to decrease the brightness. Release the button when you find a level of brightness suited to your vision needs.
6. Press the red **POSITION LOCATOR** button  located just below the **MAGNIFICATION** dial. Notice that a red dot appears on the page. This dot indicates where the TOPAZ camera is pointing. You can use the Position Locator beam to determine where you should position items that you want to magnify.

7. Locate the red **TABLE LOCK** slider on the top of the reading table. This slider controls how easy the table is to move. Place your fingers in the well just above the slider. Use your thumb to move the slider up towards the center of the reading table. This makes the table easier to move. You can move the slider in the opposite direction to make the table harder to move or to lock it into place.

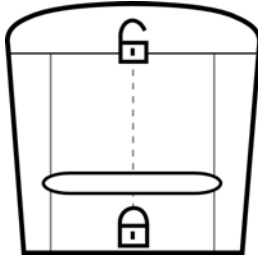

*Table Lock slider.*

8. Place your fingertips on the gray surface of the reading table. Move the table until the red dot from the Position Location beam appears at the beginning of the sentence below this paragraph. Then, press the **POSITION LOCATOR** button  to turn off the Position Locator beam. As you read the sentence below, move the reading table slowly to the left. When you reach the end of the sentence, move the reading table up and to the right so you can read the next step.

**The quick brown fox jumps over the lazy dog.**

9. Congratulations! You have successfully read with TOPAZ. For more information on using and customizing TOPAZ, refer to the relevant sections in this guide.

## Using the TOPAZ Camera Controls

The following diagram illustrates the various controls located on the front of the TOPAZ. These controls allow you to change how the magnified image displays on the screen. Each control on the camera module is described from left to right.

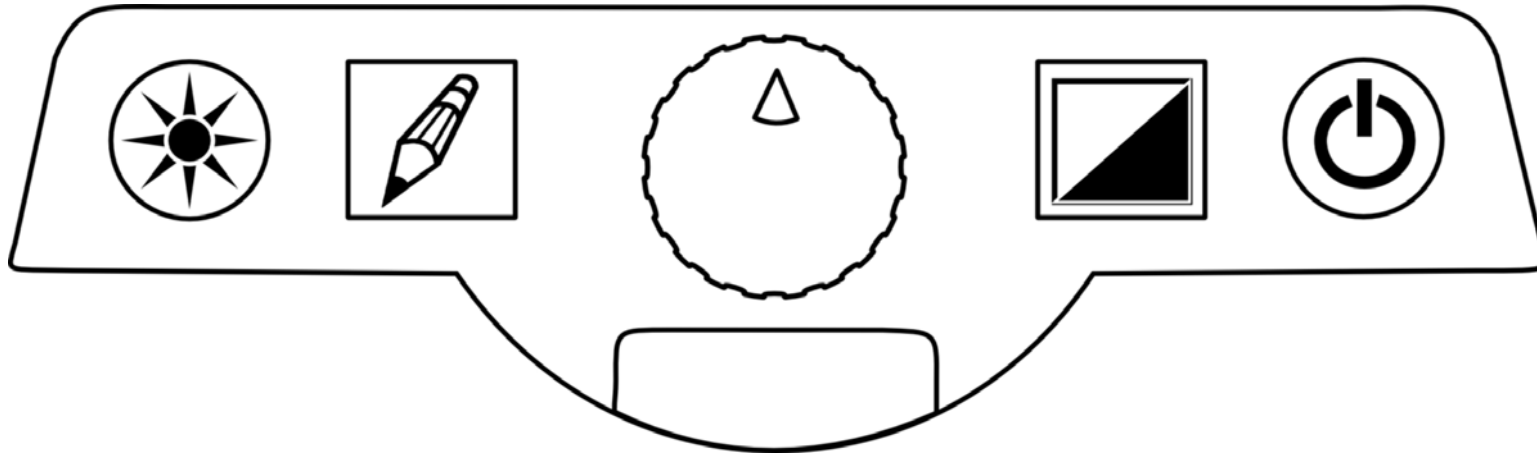

*TOPAZ camera controls.*

### Brightness Button (Yellow)

Press the yellow **BRIGHTNESS** button  and hold it down to change the level of brightness. The function of the button alternates between increasing brightness and decreasing brightness each time you use it.

## Focus Lock Button (Orange)

Press the orange **FOCUS LOCK** button  to turn Auto Focus on or off. When Auto Focus is on, the camera automatically focuses on the object closest to the camera. When Auto Focus is off, TOPAZ does not adjust the camera focus. Turning Auto Focus off makes it easier to write or work with an object, because the camera will not automatically focus on your hand. During normal operation, it is recommended that you leave Auto Focus on.

**Tip:** When you press this button, a padlock icon temporarily appears on the screen when Auto Focus is off.

## Magnification Dial

The **MAGNIFICATION** dial is located in the center of the camera control panel. This control allows you to change the level of magnification. A high level of magnification can help you see small text and details. A low level of magnification allows you to see more of the item on the screen. Turn the **MAGNIFICATION** dial to the left to decrease the magnification level. Turn the **MAGNIFICATION** dial to the right to increase the magnification level.

**Tip:** When you turn this dial, the current magnification level temporarily appears in the lower left corner of the screen. Level 1 is the lowest level of magnification and level 16 is highest level.

## Position Locator Button (Red)



The red **POSITION LOCATOR** button  is located just below the **MAGNIFICATION** dial. Press this button to turn the Position Locator beam on or off. When on, a red dot appears on your document at the location where the camera is pointing. This helps you determine where to position items that you want to magnify so they are visible on the screen.

## Video Mode Button (Blue)

Press the blue **VIDEO MODE** button  to cycle through the available video modes. You can choose from full color, enhanced positive image (black on white), enhanced negative image (white on black), yellow on blue, and yellow on black. Use the video mode that best suits your vision requirements.

NOTE: Video modes are configurable. The minimal configuration for this control is full color, enhanced positive image (black on white), enhanced negative image (white on black). To add or delete video modes see *Appendix: Advanced Video Controls* on page 31.



## Power Button (Green)

Press the green **POWER** button  to turn the power on for the monitor, camera, and lights. To turn the power off, press and hold the green **POWER** button .

**Note:** The monitor will automatically enter sleep mode when you turn off TOPAZ.

## Reading with TOPAZ

TOPAZ lets you magnify almost anything. Use it to read books, magazines, medicine bottles, small text on objects, letters, or any other type of document. You can also use TOPAZ to look at pictures and other images. To magnify an item, do the following:

1. If the power is off, press the green **POWER** button  to turn the power on.
2. Place the item you want to magnify on the reading table. A magnified image of the item appears on the screen.
3. If you have difficulty determining where to position the item, use the Position Locator beam. The Position Locator beam projects a red dot onto the reading table. TOPAZ magnifies anything near this red dot. To turn on the Position Locator beam, press the red **POSITION LOCATOR** button  just below the **MAGNIFICATION** dial. To turn the Position Locator beam off, press the button again.
4. You can use the **MAGNIFICATION** dial in the center of the TOPAZ camera controls to change the level of magnification. Turn the dial to the left to decrease magnification. Turn the dial to the right to increase magnification. The chart below shows the range of magnification, from level 1 to level 16, for different monitor sizes.

<b>TOPAZ Magnification Table</b>
15" monitor – 2.2x – 56x
17" monitor – 2.4x – 63x
19" monitor – 2.7x – 70x
21" monitor – 3x – 78x

5. Move the reading table to position the item so as to magnify the desired portion. For more information on loosening or restricting the movement of the reading table, see *Using the Reading Table* on page 20.
6. If you want to change the video mode or brightness for easier reading, see *Adjusting the Picture* on page 18.

## **Adjusting the Picture**

TOPAZ allows you to change the brightness of the screen and choose from a number of different video modes. Choose the combination of brightness and colors that best suit your vision needs.

## Changing the Brightness

A high level of brightness can help you see more details on the screen. A lower level of brightness can reduce glare and eye strain. Your changes to the brightness apply only to the currently selected video mode. Each video mode can have a different brightness setting. For information on video modes, see *Changing the Video Mode* on page 19.

To change the level of brightness, press the yellow **BRIGHTNESS** button  and hold it down. The first time you press and hold the button, the brightness level increases. The second time you press and hold the button, the brightness level decreases. The next time you press and hold the button, the brightness level increases again. The function of the button alternates between increasing brightness and decreasing brightness each time you use it.

## Changing the Video Mode

TOPAZ provides you with several preset video modes: full color, enhanced positive image (black on white), enhanced negative image (white on black), yellow on blue, and yellow on black. To cycle through the available video modes, press the blue **VIDEO MODE** button . Each press of the button changes the TOPAZ screen to the next available video mode.

You can change the last two video modes and choose up to seven additional ones. Each optional video mode consists of two colors: a foreground color and background color. For more information on choosing additional custom video modes, see *Appendix: Advanced Video Controls* on page 31.

## Using the Reading Table

The reading table allows you to easily move items that you want to magnify without touching them. For example, if you want to read a document at high magnification, you would first move the table towards you and to the right to focus on the beginning of a sentence. As you read, you would move the table slowly to the left. Once you reached the end of the line, you would move the table away from you slightly and then back to the right.

The reading table can move up to 10.5 inches vertically and up to 16 inches horizontally. You can use the **TABLE LOCK** slider to adjust the resistance of the reading table, making it easier or harder to move. A higher level of resistance allows you more control and keeps the table from moving accidentally. You can also lock the table in place so that it does not move at all. A lower level of resistance is useful when you need to move the table frequently, such as when reading a book at high magnification.

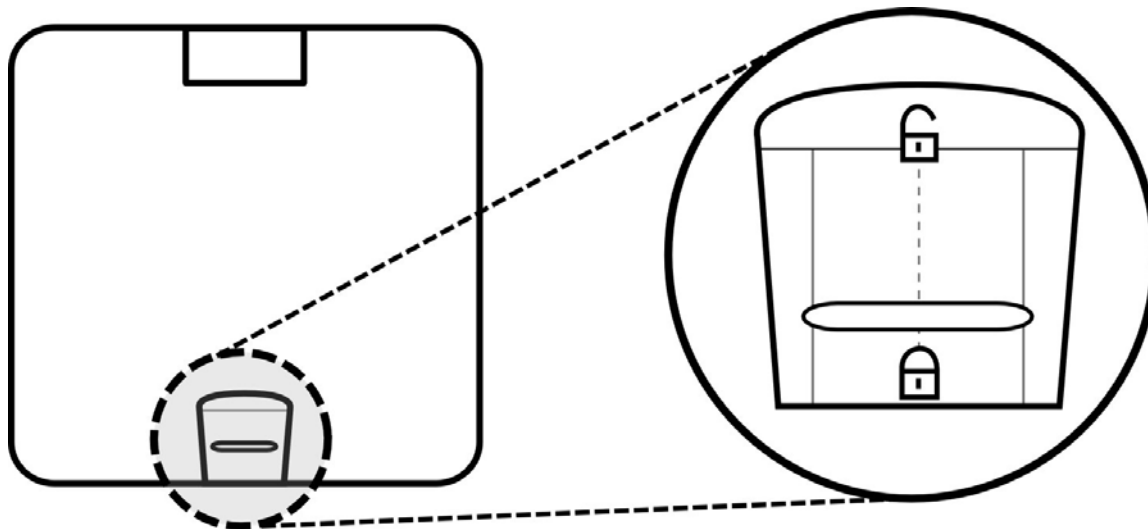

*Reading table and a close-up view of the Table Lock slider.*

To decrease the reading table's resistance, do the following:

1. Locate the red **TABLE LOCK** slider on the top of the reading table.
2. Place your fingers in the well just above the **TABLE LOCK** slider.
3. Use your thumb to push the **TABLE LOCK** slider up. The higher you push the slider, the easier the table will be to move.

To increase the reading table's resistance or lock it in place, do the following:

1. Locate the red **TABLE LOCK** slider on the top of the reading table.
2. Place your thumb against the edge of the reading table, just below the **TABLE LOCK** slider.
3. Use your fingers to pull the **TABLE LOCK** slider down. The lower you move the slider, the harder the table will be to move. Move the slider all the way to the bottom to lock the table into place.

## Adjusting the LCD Flat Panel Monitor

Some TOPAZ models feature LCD flat panel screens. These models allow you to change the height and angle of the monitor for the best view and for more neck and upper back comfort.

To adjust the LCD monitor, do the following:

1. Use your hands to grip both sides of the flat panel monitor.
2. Gently move the monitor up or down until you find an appropriate viewing height.
3. You can now adjust the viewing angle. To tilt the monitor up, gently push the front of the monitor with your thumbs. To tilt the monitor down, gently pull on the back of the monitor with your fingers.

## Writing or Doing Crafts with TOPAZ

TOPAZ is ideal for reading and viewing documents and images. However, you can also use it to help you write on items or complete craft projects. Use TOPAZ to fill out forms, write checks, pay bills, draft letters, complete crossword puzzles, paint, sew, assemble models, and much more.

**Tip:** When you are writing or doing crafts with TOPAZ, it is recommended that you lock the reading table in place. To do this, move the red **TABLE LOCK** slider all the way down. For more information, see *Using the Reading Table* on page 20.

TOPAZ's camera automatically focuses on the item closest to the lens. This feature is called Auto Focus. When reading or viewing items with TOPAZ, Auto Focus ensures that the item is not blurry or difficult to see. However, Auto Focus can cause the camera to focus on your hand, rather than the item on the reading table when writing or performing other activities where you must use your hands.

To write on an item or work on a craft project, do the following:

1. Place the item you want to work with on the reading table.
2. Position the reading table so that the desired area is magnified on the screen. Lock the table in place if necessary (see *Using the Reading Table* on page 20).
3. Press the orange **FOCUS LOCK** button . Auto Focus is now disabled. The camera remains focused on the item on the reading table, even if other items enter the viewing area.

## Viewing Photos and Other Glossy Items

TOPAZ has two lights designed to illuminate documents and other items that you place on the reading table. This lighting is diffused to reduce glare and reflections. However, some items, such as photographs or glossy magazine pages, may be too shiny or reflective to view easily. When viewing such items, you can turn off the lights on TOPAZ to improve the quality of the magnified image.

To turn off the unit's lights, press the **BRIGHTNESS** button  and **FOCUS LOCK** button  at the same time. Press these two buttons again when you want to turn the lights back on.

## Connecting TOPAZ to a Television

You can connect TOPAZ to a television using the television connector cable. Items that you magnify with TOPAZ will then appear on your TV screen.

**Note:** The television connector cable is included with the camera-only TOPAZ model. If you need this cable, contact Freedom Scientific and order part number 700188-007.

To connect your TOPAZ to a television, do the following:

1. Plug the square end of the television connector cable into the rectangular port located on the back of the monitor stand, near the power and video plugs.
2. Plug the other end of the video cable into one of the yellow video input jacks on your television. Refer to your television owner's manual for more information on locating the video input jacks.
3. Turn on the television. If necessary, switch to the appropriate input channel.

**Note:** Enhanced video modes are not available when the TOPAZ is connected to a television. The only options available are full color and gray scale. Therefore, when pressing the Video Mode button, you will see black and white images four times before returning to full color.

## Service and Support

You can contact Freedom Scientific Technical Support to receive technical assistance with TOPAZ. Before contacting Technical Support, it is recommended that you refer to *Troubleshooting* on page 27 to try to resolve your problem quickly.

If you cannot resolve your issue, you can visit [www.FreedomScientific.com](http://www.FreedomScientific.com). Choose the **Support** link to search the Knowledge Base. The Knowledge Base contains articles that address many common questions and technical issues concerning Freedom Scientific products.



**Note:** This device has no user-serviceable components. Any unauthorized attempt to service or replace internal components will void the product warranty.



To contact Freedom Scientific Technical Support by telephone, customers in the United States can call (727) 803-8600, Monday through Friday, from 8:30 A.M. to 7:00 P.M. (Eastern Time). Alternatively, you can receive support by e-mail. Send your questions and problems to [HardwareSupport@FreedomScientific.com](mailto:HardwareSupport@FreedomScientific.com).

When you call, have your documentation ready and be prepared to provide the following information:

- Product name
- What you were doing when the problem occurred
- How you tried to solve the problem

# Troubleshooting

Problem	Solution
The screen is blank.	<p>Ensure that the power is on and that the power light for the monitor is on.</p> <p>Check that all power cables are correctly connected.</p> <p>Reduce the magnification level.</p> <p>Press the blue <b>VIDEO MODE</b> button  to switch to a different video mode.</p>
The unit does not turn on.	<p>Ensure that the TOPAZ and monitor are both plugged in.</p> <p>Ensure that the outlet has power and is not malfunctioning. If the outlet is connected to a wall switch, make sure that the switch is on.</p>
The image on the screen is too bright, or there is a glare from the screen that makes it difficult to see.	<p>Use the yellow <b>BRIGHTNESS</b> button  to reduce the brightness (see page 19).</p> <p>Press the blue <b>VIDEO MODE</b> button  to switch to a different video mode.</p>



Problem	Solution
The image on the screen is too dark.	<p>Use the yellow <b>BRIGHTNESS</b> button  to increase the brightness (see page 19).</p> <p>Press the blue <b>VIDEO MODE</b> button  to switch to a different video mode.</p>
The image on the screen is blurry and/or unfocused.	<p>Ensure that Auto Focus is on. You can press the orange <b>FOCUS LOCK</b> button  to turn Auto Focus on or off.</p>
There are smudges or blemishes on the screen.	<p>Clean the screen using a damp, soft, lint-free cloth.</p>
Text is too small to read.	<p>Turn the <b>MAGNIFICATION</b> dial to the right to increase the magnification level.</p>
Text is too large.	<p>Turn the <b>MAGNIFICATION</b> dial to the left to decrease the magnification level.</p>

Problem	Solution
<p>TOPAZ is connected to a monitor, but no magnified image appears on the television screen.</p>	<p>Ensure that the monitor is plugged into the power port on the back of the TOPAZ monitor stand or wall outlet.</p> <p>Ensure that the monitor is on. Ensure that the monitor cable is securely connected to the video port on the back of the TOPAZ monitor stand and the back of the monitor.</p>
<p>The reading table does not move.</p>	<p>Ensure that the table is not locked in place. Move the red <b>TABLE LOCK</b> slider up towards the center of the reading table.</p> <p>Ensure that there are no obstructions in the table's tracks or the work surface.</p>
<p>TOPAZ is connected to a television, but no magnified image appears on the television screen.</p>	<p>Ensure that the television is on, and switch to the appropriate video input channel on your television.</p> <p>Ensure that the television connector cable is securely connected to the appropriate TOPAZ port and video input jack.</p>

<b>Problem</b>	<b>Solution</b>
Bouncing white box on the LCD screen (white box that reads digital, check signal cable).	Remove Freedom Scientific label on the monitor bezel and press the ENTER button. The ENTER button is the second button from the right side of the monitor and has an arrow pointing to the left.

## Appendix: Advanced Video Controls

TOPAZ has an advanced configuration menu that allows you to assign custom video modes and adjust the brightness, contrast, color, tint, zoom position display, and focus lock display.

To access this configuration menu, hold down the red **POSITON LOCATOR** button  for approximately 10 seconds. Then, press **POSITON LOCATOR** button  to cycle through the following menu options:

- Text Enhancement. **See page 32**
- Brightness. **See page 34**
- Contrast. **See page 34**
- Color. **See page 36**
- Tint. **See page 36**
- Zoom Position Display. **See page 38**
- Focus Lock Display. **See page 39**

## Choosing Custom Video Modes

TOPAZ allows you to cycle through up to twelve different video modes. The first three video modes are fixed and cannot be changed. However, you can choose up to nine additional video modes from a wide variety of pre-defined color choices. Once you assign a video mode to one of the nine available positions, you can switch to it by pressing the **VIDEO MODE** button .

**Tip:** The video modes black and white, yellow on blue, and blue on yellow are already assigned to the fourth, fifth, and six positions respectively. You can replace these video modes with others if you prefer.

To assign video modes to one or more of the nine available positions, do the following:

7. Press and hold the red **POSITION LOCATOR** button  for approximately 10 seconds until you see a **T** (which stands for text enhancement) display in the lower left corner of the screen.

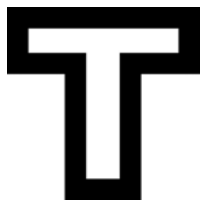



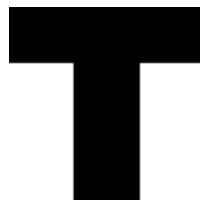

*Text Enhancement icon  
(hollow outline - no  
modifications allowed)*



*Text Enhancement icon  
(solid figure - modifications  
permitted)*

**Note:** If the **T** symbol appears as a hollow outline, then you cannot assign a different video mode to that position. The symbol will flash if you attempt to modify the position. You can only choose a different video mode if the **T** symbol is solid.



8. Press the **VIDEO MODE** button  until the number of the position that you want to assign the video mode to appears on the screen.
9. Press the yellow **BRIGHTNESS** button  to cycle through the available video modes until you find the one you want to assign to the current position.
10. Press the orange **FOCUS LOCK** button  to make the position active. A check mark appears next to the slot number in the lower left corner of the screen to indicate that it is active. An **X** indicates that the position is inactive. You cannot switch to a video assigned to an inactive position by pressing the **VIDEO MODE** button  during normal operation. If a check mark already appears next to the position number, you can skip this step.
11. If you want to change the default brightness or contrast of the video mode, see *Changing the Brightness and Contrast for Custom Video Modes* on page 34.
12. Repeat steps 2 through 5 as necessary. You can assign a video mode to each of the nine positions. You cannot change the video modes assigned to positions one through three.
13. When you have finished selecting the color schemes you want to use, hold down the **POSITION LOCATOR** button  until the on-screen display is no longer visible to save your settings.

**Tip:** If you decide that you do not want to save your color selections, wait for a short time until the on-screen display disappears. Your selections are not saved.

To switch to one of your custom video modes during normal operation, press the **VIDEO MODE** button  until the desired video mode is active.

## Changing the Brightness and Contrast for Custom Video Modes

You can define the default brightness and contrast for each of the custom video modes. To change the brightness and contrast for a video mode, do the following:

14. If you are not already in customization mode, press and hold the red **POSITION LOCATOR** button  for approximately 10 seconds until you see a **T** display in the lower left corner of the screen.
15. Press the **VIDEO MODE** button until you select the position containing the video mode you want to adjust.
16. Press the **POSITION LOCATOR** button . You should see the following **Brightness** icon on the screen.



*Brightness icon.*

17. To increase the brightness, press the **VIDEO MODE** button  until you move the slider to the desired level of brightness.

- or -

To decrease the brightness, press the **FOCUS LOCK** button  until you move the slider to the desired level of brightness.

18. Press the **POSITION LOCATOR** button  again. You should see the following **Contrast** icon on the screen.



*Contrast icon.*

19. To increase the contrast, press the **VIDEO MODE** button  until you move the slider to the desired level.

- or -



To decrease the contrast, press the **FOCUS LOCK** button  until you move the slider to the desired level.

**Tip:** You can invert the colors on the screen by moving the slider all the way to the left.

20. Hold down the **POSITION LOCATOR** button  until the on-screen display is no longer visible to save your settings.

## Changing the Color and Tint

Do the following to adjust the level of color saturation and tint for the full color video mode. You cannot adjust the color and tint for any of the other video modes.

21. Press and hold the red **POSITION LOCATOR** button  for approximately 10 seconds until you see a **T** display in the lower left corner of the screen.
22. If full color mode is not already active, press the **VIDEO MODE** button  until position 1 is active.
23. Press the **POSITION LOCATOR** button  three times. You should see the following **Color** icon on the screen.

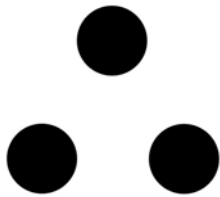

*Color icon.*

24. To increase the color saturation, press the **VIDEO MODE** button  until you move the slider to the desired level of color.

- or -

To decrease the color saturation, press the **FOCUS LOCK** button  until you move the slider to the desired level of color.

25. Press the **POSITION LOCATOR** button  again. You should see the following **Tint** icon on the screen.



*Tint icon.*

26. To increase the tint, press the **VIDEO MODE** button  until you move the slider to the desired level of tint.



- or -

To decrease the tint, press the **FOCUS LOCK** button  until you move the slider to the desired level of tint.

27. Hold down the **POSITION LOCATOR** button  until the on-screen display is no longer visible to save your settings.



## Hiding the Zoom Position Display

When you move the Magnification dial, TOPAZ displays the current magnification level in the lower left corner of the screen. If you do not want this information to display, do the following:

28. Press and hold the red **POSITION LOCATOR** button  for approximately 10 seconds until you see a **T** display in the lower left corner of the screen.
29. Press the **POSITION LOCATOR** button  five times. You should see the following **Zoom Position Display** icon on the screen.





*Zoom Position Display icon.*

30. Press the **VIDEO MODE** button . The check mark on the screen changes into an **X**.
31. Hold down the **POSTION LOCATOR** button  until the on-screen display is no longer visible to save your settings.

**Tip:** To show the zoom position on screen again, repeat steps 1-4.



## Hiding the Focus Lock Display

When you press the **FOCUS LOCK** button , a small padlock icon appears on the screen when you turn Auto Focus off. If you do not want this information to display, do the following:

32. Press and hold the red **POSITION LOCATOR** button  for approximately 10 seconds until you see a **T** display in the lower left corner of the screen.
33. Press the **POSITION LOCATOR** button  six times. You should see the following **Focus Lock Display** icon on the screen.



*Focus Lock Display icon.*



34. Press the **VIDEO MODE** button . The check mark on the screen changes into an **X**.
35. Hold down the **POSITION LOCATOR** button  until the on-screen display is no longer visible.

**Tip:** To show the focus lock indicator on the screen again, repeat steps 1-4.

## Reset Factory Default

Press the red **POSITION LOCATOR** button , blue **VIDEO MODE** button , orange **FOCUS LOCK** button , and the yellow **BRIGHTNESS** button  simultaneously for 10 seconds in order to reset your TOPAZ to the default factory settings.

## Minimal Video Mode Configuration

To set a minimal configuration of full color, enhanced black on white, and enhanced white on black, hold the yellow **BRIGHTNESS** button  and the blue **VIDEO MODE** button  for 10 seconds.