

TOPAZ[®] PHD
Portable Video Magnifier
User's Guide

Freedom Scientific, Inc.

www.FreedomScientific.com

440774-001 Revision F

Freedom Scientific, Inc., 11800 31st Court North, St. Petersburg, Florida 33716-1805, USA
www.FreedomScientific.com

© 2015 Freedom Scientific, Inc. All Rights Reserved. TOPAZ® and GEM® are trademarks of Freedom Scientific, Inc. in the United States and other countries. Information in this document is subject to change without notice. No part of this publication may be reproduced or transmitted in any form or by any means electronic or mechanical, for any purpose, without the express written permission of Freedom Scientific.

To register your product, visit <http://www.freedomscientific.com/forms/ProductRegistration>.

Safety and Maintenance

To keep the unit in good condition and to ensure safe usage, observe the following guidelines:

- Read the instructions in this user's guide before attempting to use the unit.
- Do not attempt to repair the unit or open its case. This product contains no user serviceable parts.
- Keep the unit away from wet areas, rain, and other sources of liquids or high humidity. Do not submerge the unit.
- Always operate the unit in a place where the temperature is between 10° and 40° C (50° and 104° F).
- Always store the unit in a place where the temperature is between -20° and 65° C (-4° and 149° F).
- Always use the unit on a stable, level, hard surface such as a desk or table.
- When cleaning the screen, camera lens, or self-view lens, unplug the power cord and apply a small amount of non-abrasive cleanser, such as the following, to a soft, lint-free cloth and gently wipe:
 - Water
 - Isopropyl alcohol
 - Petroleum benzene
 - Vinegar mixed with water at a concentration of no more than 10 percent vinegar, for example, 1.5 tablespoons of vinegar per cup of water (100 ml per liter)

CAUTION:

Do not apply excessive pressure to the screen, camera, or self-view lens. Do not spray cleanser directly on these items. Also, do not use any cleanser that contains the following agents: acetone, ethyl alcohol, ethyl acid, ammonia, or methyl chloride.

When cleaning the rest of the unit, make sure the unit is unplugged. Use a lightly dampened, soft, clean cloth with water or mild detergent.

Welcome to TOPAZ PHD	1
Setting Up the Unit	3
Powering the Unit.....	3
Opening the Unit	4
Closing the Unit.....	6
Manually Powering the Unit On and Off	7
Battery Status	8
Control Panel Functions	9
Control Panel – Basic Functions	9
General Operation	10
Changing Magnification.....	10
Adjusting Screen and Image Brightness	10
Changing Screen Colors	11
Freezing an Image	12
Using the Find Feature.....	12
Self-view Camera.....	13
Advanced Operation.....	15
Control Panel – Advanced Features.....	15
Adjusting LED Brightness	16
Saving an Image	16
Reviewing or Deleting Images Saved on an SD Card	17
Displaying a Slide Show.....	18
Reading Lines and Reading Masks.....	19
Adding and Removing Color Modes.....	20
Restoring Factory Settings.....	21
Appendix A - Color Modes	22
Appendix B - Changing and Saving Settings	23

Appendix C - Adjusting Magnification Settings	25
Selecting a Magnification Table	25
Changing the Magnification Display Number.....	26
Appendix D - Configuration Menu Settings	28
Appendix E - Changing the Battery	31
Removing the Battery.....	31
Replacing the Battery.....	33
Setting Date and Time	34
Appendix F - Troubleshooting	35
Appendix G - Service and Support.....	37

The TOPAZ[®] PHD is a lightweight portable video magnifier. Its collapsible design makes it easy for travel.

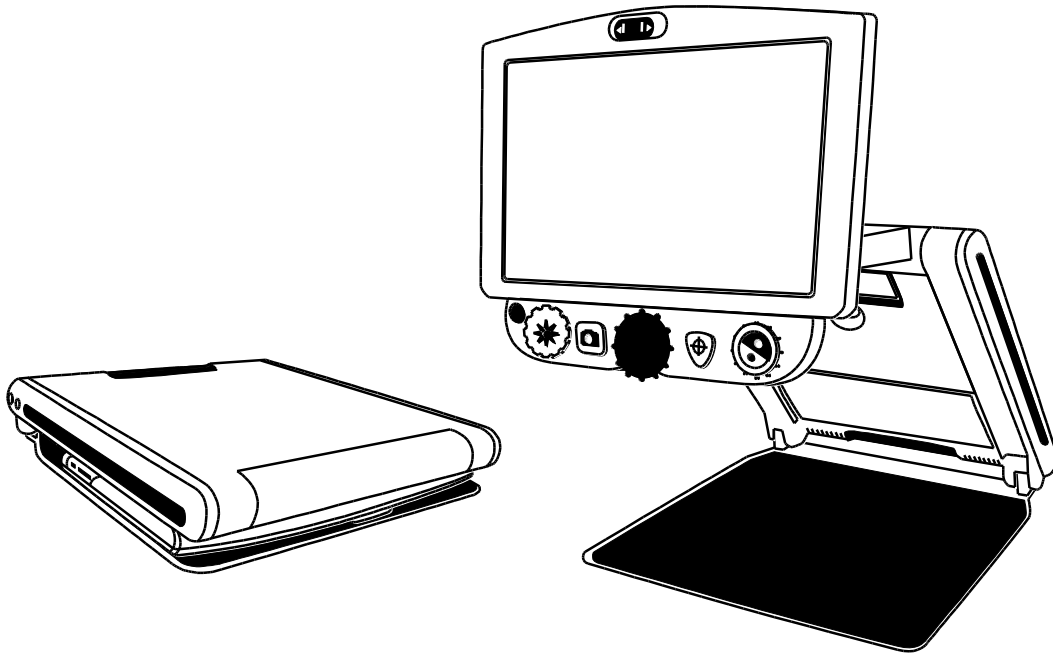

The unit includes the following features:

- High-definition camera with auto-focus lens that displays high-quality images
- Magnification from 1.7x to 24x (12-inch model), and 2.3x to 31x (15-inch model)
- Six default color modes; 27 configurable color modes
- Freeze Frame to capture the current image on screen
- Find function to briefly zoom out and easily locate the center of the object displayed on the screen
- Adjustable Reference Lines and Masks to emphasize an area displayed on the screen
- SD Card slot – capture and save images to an installed SD Card
- USB port for connectivity to computer using GEM[®] software
- Self-view camera – magnification from 1x to 2.5x

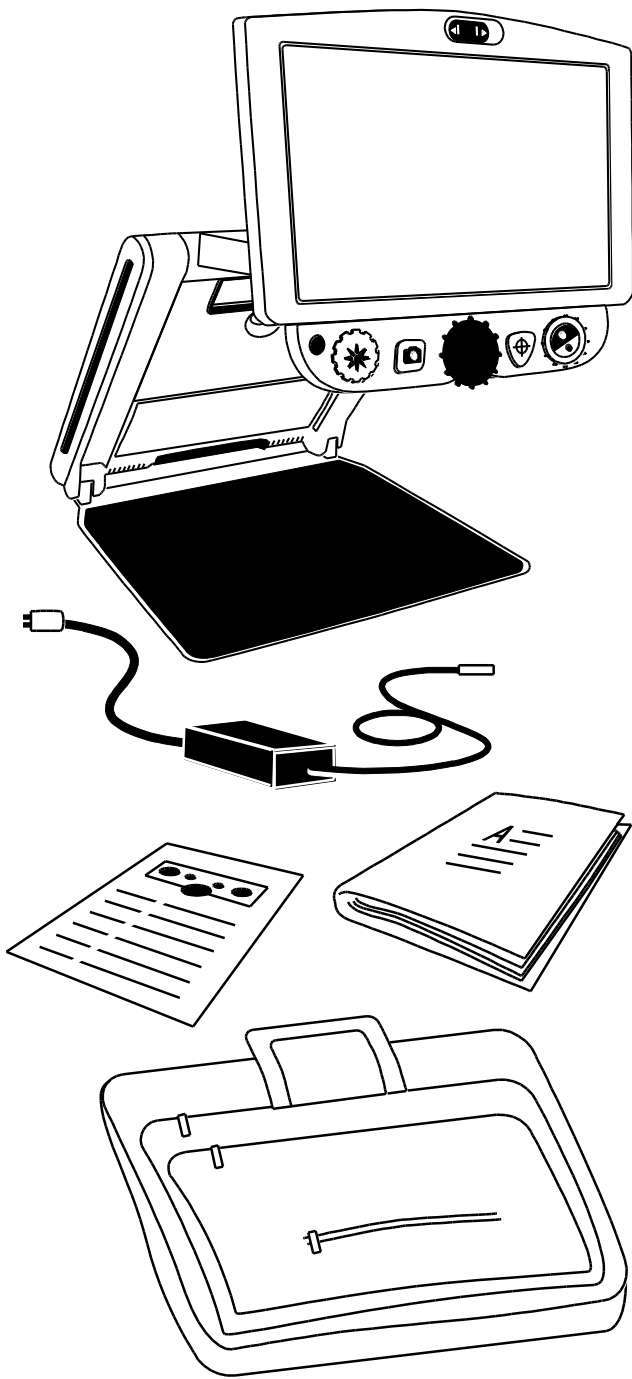

What's in the Box

- TOPAZ PHD portable video magnifier with 12-inch or 15-inch flat-panel monitor
- Power adapter and cord
- User documentation
- Carrying case
- Li-ion battery (optional)

Powering the Unit

To power the unit or charge the battery, do the following:

1. Plug the power adapter cord into the unit's power jack (1). The jack is located on the left side of the unit next to the POWER button .
2. Plug the power cord (2) into a wall outlet.

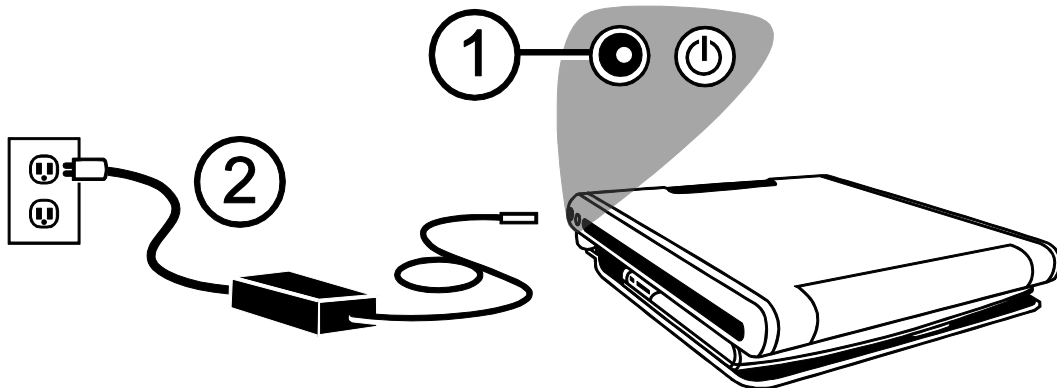

An optional Li-ion battery is available for the unit. It provides approximately 4 hours of use and takes approximately 3.5 hours to fully charge.

Refer to *Battery Status* on page 8 for information about battery operation.

To insert or remove a battery, see *Changing the Battery* on page 31.

Opening the Unit

Note: To apply power to the unit, make sure it is plugged into an AC outlet or that an optional battery is installed and charged. You can still use the unit while it is charging.

1. Place the unit on a sturdy, stable work surface.
2. Place two fingers on the left or right front corner of the unit's baseplate (1).

With your other hand, grip the front edge of the unit's body (2).

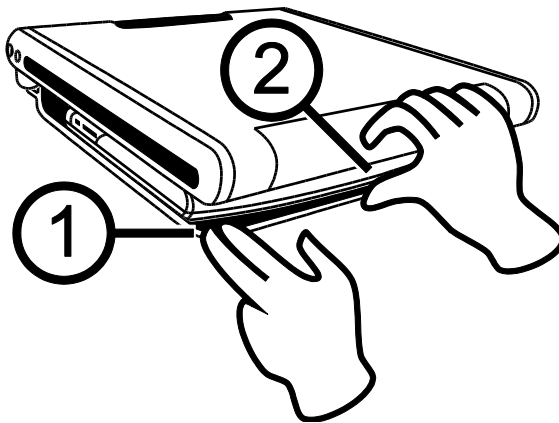

3. Raise the body until it locks in place (3).

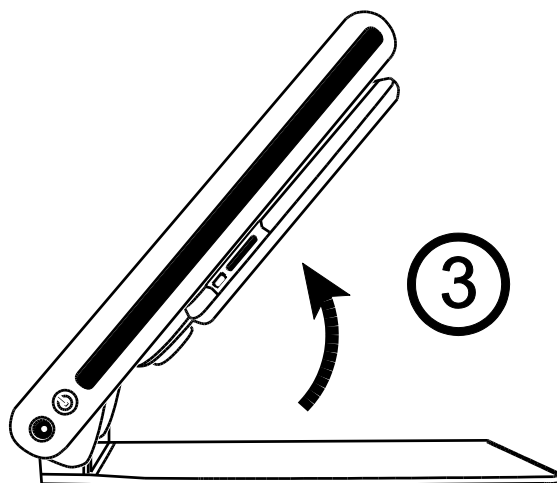

- Place both hands along the left and right sides of the monitor, and pull it toward you (4 and 5). The unit automatically powers on as you move the monitor from its closed position.

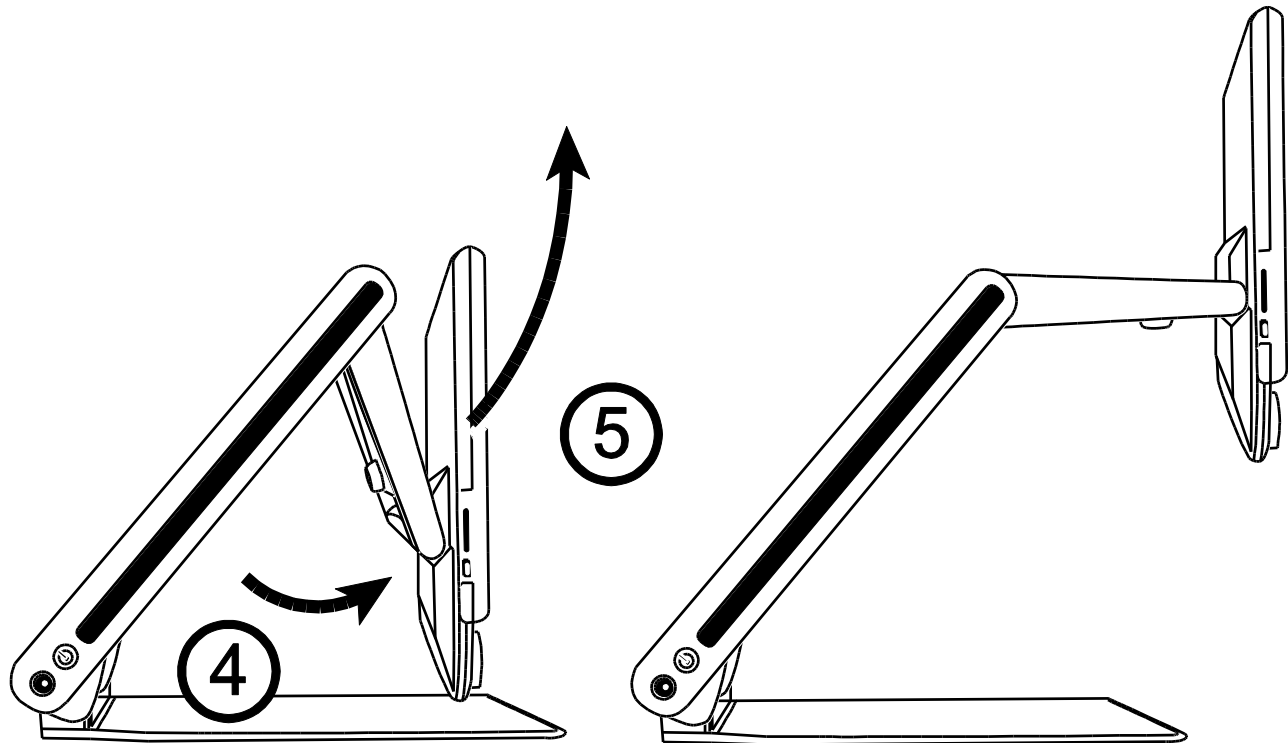

- Finally, raise, lower, or tilt the monitor to a position that is comfortable for you. After a few moments, the screen turns on.

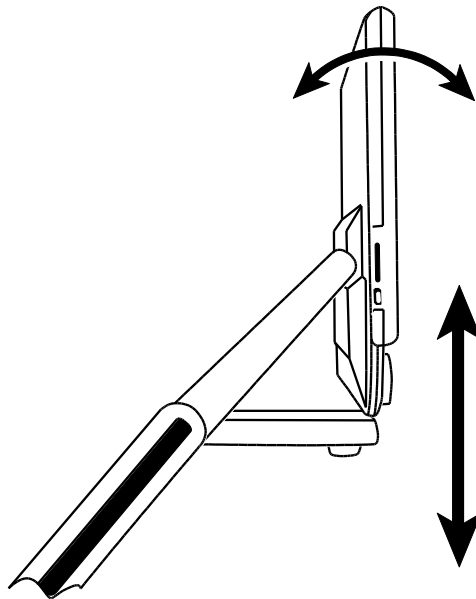

Note: If a battery is installed, and the unit does not power on, plug the unit into an AC outlet, or press the POWER button. The power connector and POWER button are located on the left side of the unit.

Closing the Unit

1. To close the unit, use both hands to lower and rotate the monitor until it is against the unit's body.

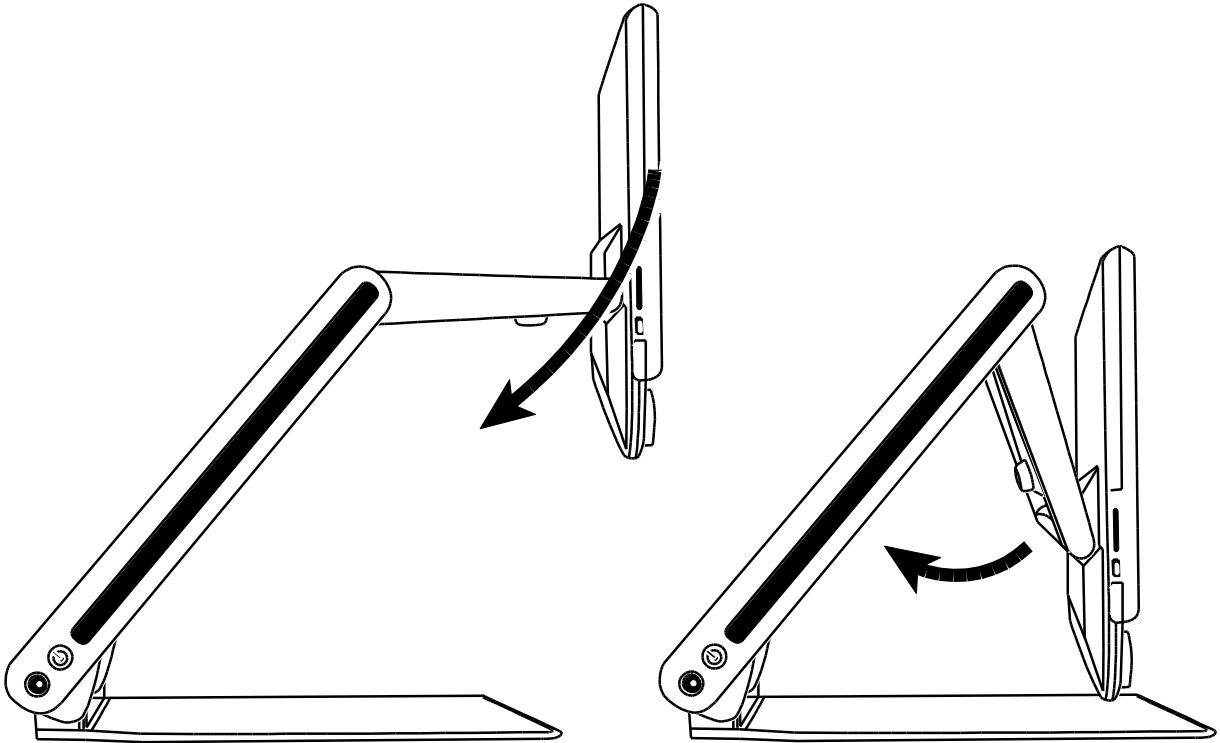

2. Place both hands on the left and right sides of the body, and lower it until the unit is closed. The unit automatically powers off.

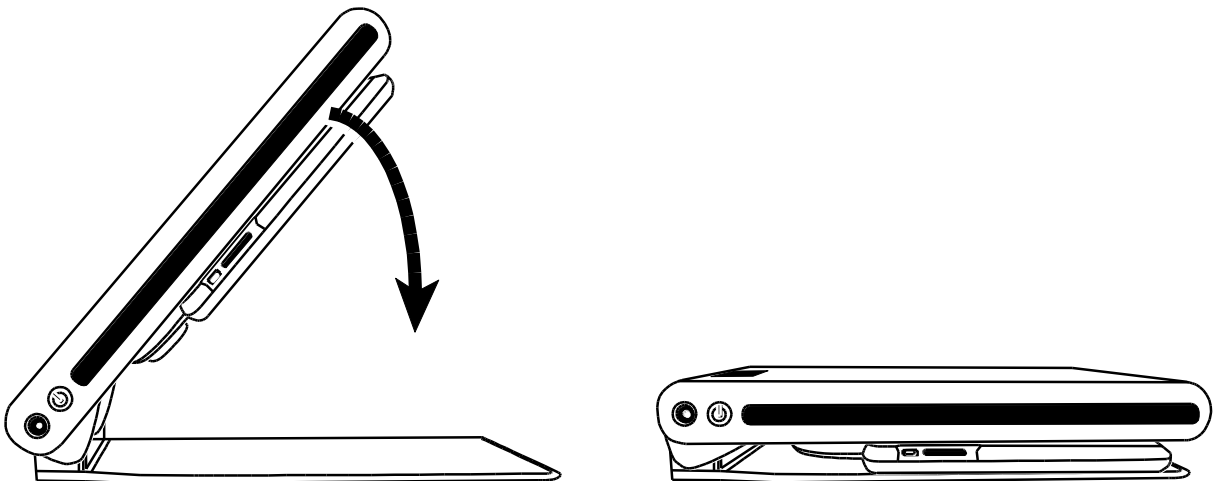

Manually Powering the Unit On and Off

The unit automatically powers on when you open it and move the monitor from its closed position. The unit powers off when you collapse and close it.

To manually power the unit on and off, do the following:

1. Press the POWER button . It is located next to the power jack on the left side of unit.

If the unit is off, the reading light turns on, and the camera's current view displays on the screen.

2. If an image does not display on the screen, try the following:

- Press the POWER button  on the side of the unit
- Make sure the power cord is connected to the unit
- Make sure the power cord is plugged into a power outlet
- If a battery is installed, verify that it is charged. A flashing red LED indicates low battery. See *Battery Status* on page 8 for more information.
- Ensure that the wall outlet has power and is not malfunctioning. If the outlet is connected to a wall switch, make sure the switch is on.
- For more solutions, refer to *Troubleshooting* on page 35

3. To turn the unit off, press the POWER button  again.

Battery Status

The POWER button  is a multi-color LED (green/red) that indicates battery status when an optional battery is installed in the unit. The button is located next to the power jack on the left side of the unit.

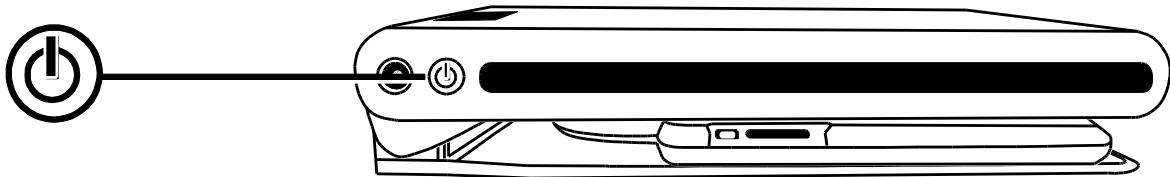

Green – Solid: Battery charged – power adapter connected.

Green – Flashing: Battery charging – power adapter connected.

Red – Flashing: Battery low – less than 10 percent remaining.

Red – Solid: Error – if a power adapter is connected, unplug it, wait a few seconds, and plug it in again. If this condition persists, change the battery or contact Technical Support.

No LED: Battery charge ok, power adapter not connected; or unit is off.

Note: To save battery life, the unit powers off automatically if it is idle for 30 minutes.

If the unit is connected to AC power, it will continue to run and not power off after 30 minutes.

Control Panel Functions

Control Panel – Basic Functions

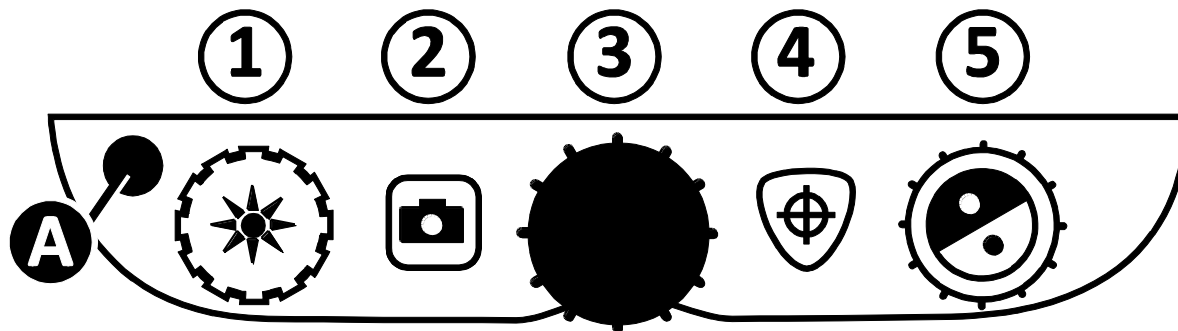



(1) BRIGHTNESS (Yellow dial)	Turn clockwise to increase screen brightness. Turn counterclockwise to decrease screen brightness.
(2) FREEZE FRAME (Red button)	Press to freeze the image that is displayed on the screen. Press again to return to live view. Press and hold for approximately six seconds to enter or exit Review mode. See <i>Reviewing or Deleting Images Saved on an SD Card</i> on page 17 for more information.
(3) MAGNIFICATION (Black dial)	Turn to zoom in and increase magnification or zoom out and decrease magnification
(4) FIND (Orange button)	Press and hold to zoom out and display crosshairs on the screen to help you reposition the object under the camera. Release to return to the previous magnification level.
(5) COLOR MODE (Blue dial)	Turn to cycle through color modes. See <i>Color Modes</i> on page 22 for more information.
(A) ADVANCED (Black button)	Use in combination with other controls to access and perform advanced features. See <i>Advanced Operation</i> on page 15 for more information.

Changing Magnification

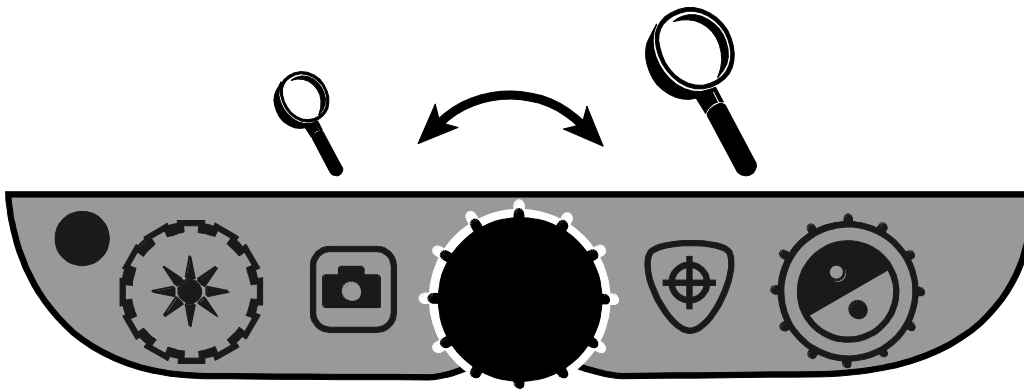
Turn the center black **MAGNIFICATION** dial  clockwise to zoom-in and enlarge, or counterclockwise to zoom away from the object that is displayed on the screen.



Adjusting Screen and Image Brightness

- To make the image lighter, turn the yellow **BRIGHTNESS** dial  clockwise.
- To make the image darker, turn the yellow **BRIGHTNESS** dial  counterclockwise.

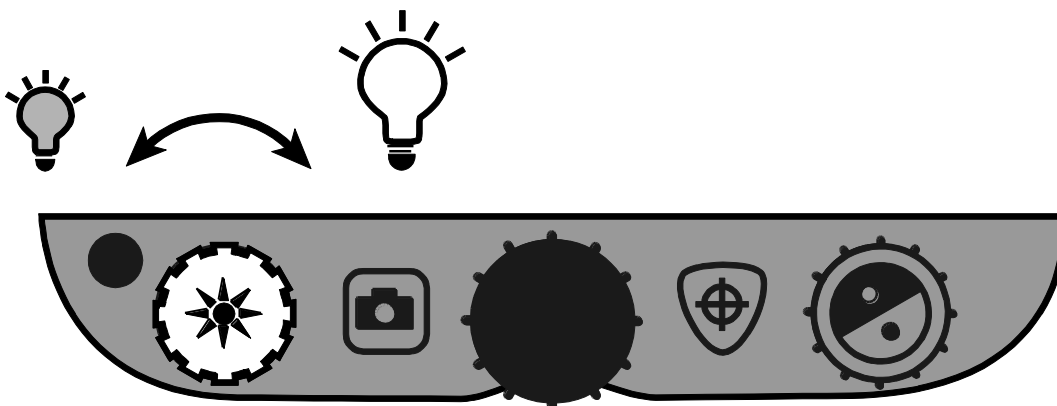

Changing Screen Colors

To change screen colors, turn the blue **COLOR MODE** dial .

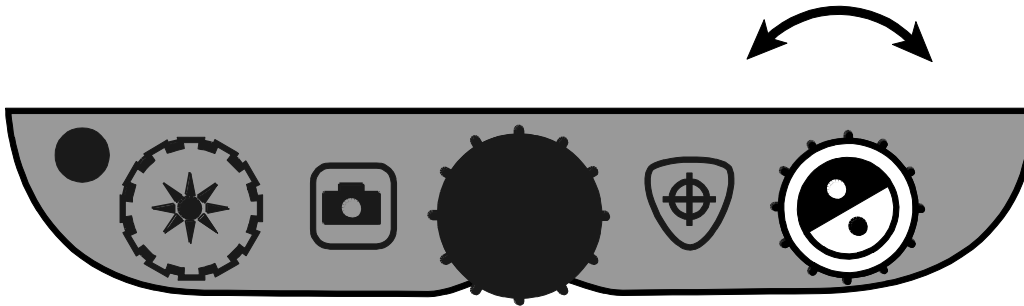

A color mode is a pre-defined color combination (for example, yellow text on a black background). You can use color modes to reduce glare and provide contrast to make it easier to read text on the screen. There are six default color modes:

- True Full Color – always available, cannot be deleted
- Black on White (high-contrast positive) – always available, cannot be deleted
- White on Black (high-contrast negative) – always available, cannot be deleted
- Yellow on Blue
- Yellow on Black
- High-Contrast Full Color

You can also activate up to 27 additional color modes for a total of 33. For a complete list, refer to *Color Modes* on page 22. To add more color modes, refer to *Adding and Removing Color Modes* on page 20.

Freezing an Image

To freeze the image displayed on the screen, do the following:

1. Press the red **FREEZE FRAME** button . The Freeze Frame icon  displays on the screen.

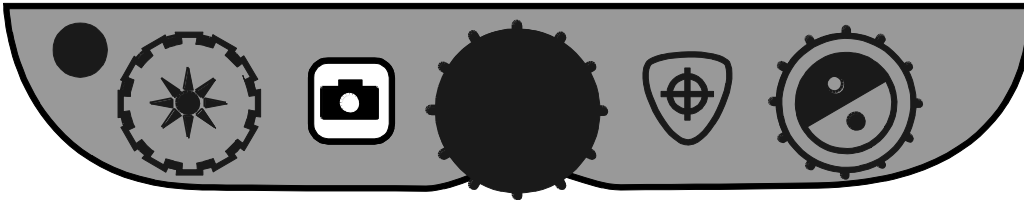

2. Press the button again to turn off Freeze Frame and return to live view.

Using the Find Feature

The Find feature is useful when moving and repositioning a document or item under the camera. Crosshairs display on the screen to assist with positioning.

1. Press and **hold** the orange **FIND** button .

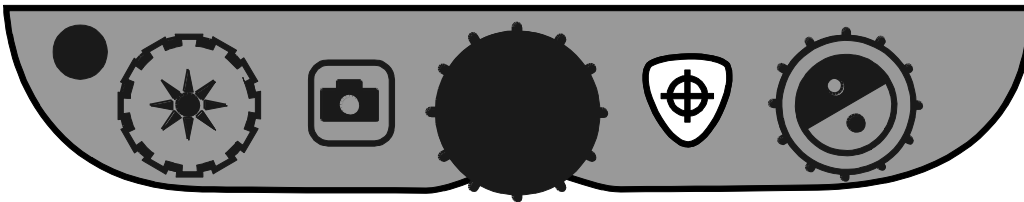

Crosshairs display on the screen (indicating the center of the image on the screen), and the camera zooms out.

2. While still holding the button, move the item until the crosshairs shown on the screen align with the new area that you want to view.
3. Release the orange **FIND** button .

The camera zooms in to its previous magnification level and the crosshairs turn off.

Self-view Camera

The self-view camera is located at the top center of the monitor. Use it to see yourself on the screen.

1. To select the self-view camera, move the camera cover to the right.

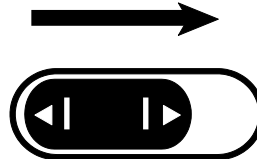

The unit switches to its self-view camera, and displays the self-view icon on the screen.

2. While sitting in front of the unit, position the display at an angle that is comfortable for you.

If necessary, hold the left and right sides of the display, and then gently tilt it forward or backward to adjust the angle, or lift it up or down to adjust the height.

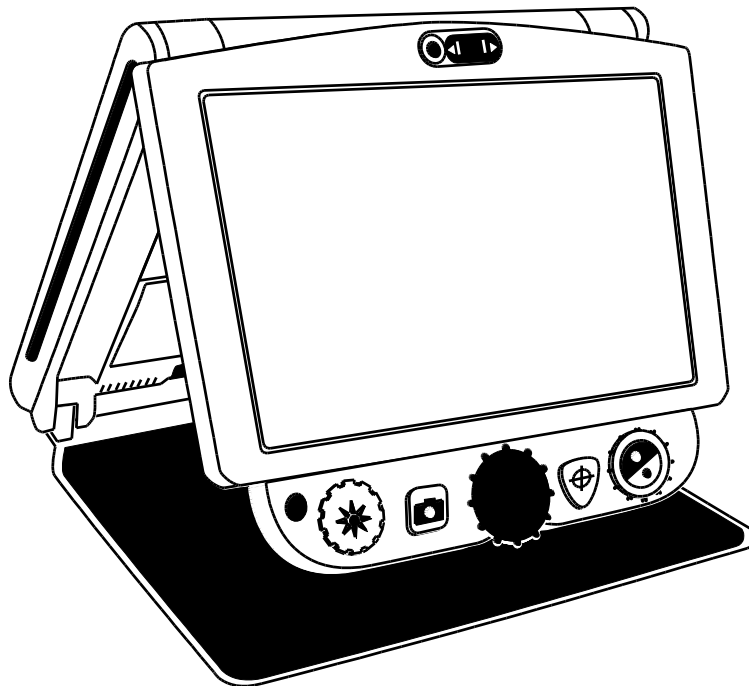

While in Self-view mode,

- You can turn the black **MAGNIFICATION** dial to zoom in and out
 - You can freeze or save the image displayed on the screen. For more information, see *Freezing an Image* on page 12, or *Saving an Image* on page 16.
 - You can change screen brightness as described on page 10
3. To disable the self-view camera, move the camera cover to the left.

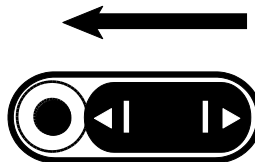

The screen now displays the main camera's view.

Control Panel – Advanced Features

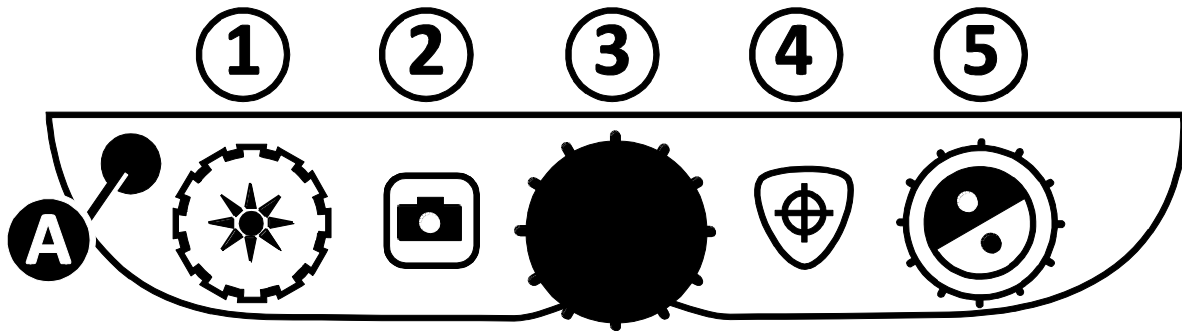

IMPORTANT:

The black **ADVANCED** button (**A**) is used with other control panel buttons and dials to access and perform more features and operations.



Always **press and hold** the **ADVANCED** button (**A**) first, and then press or turn the other buttons or dials to perform the advanced task.

For example, to dim or brighten the LED reading light, first **press and hold** the **ADVANCED** button (**A**), and then turn the yellow **BRIGHTNESS** dial (1).

(A + 1)	BRIGHTNESS (Yellow dial)	Turn to adjust the LED reading light brightness.
(A + 2)	FREEZE FRAME (Red button)	Press and hold to save the current image to an SD Card. Release when the Save icon appears on the screen. Images can only be saved when an SD Card is in the SD Card slot.
(A + 3)	MAGNIFICATION (Black dial)	Turn to cycle through and display horizontal lines, horizontal masks, vertical lines, vertical masks, and no lines or masks on the screen.
(A + 4)	FIND (Orange button)	Press and hold for approximately 10 seconds to enter or exit Configuration mode.
(A + 5)	COLOR MODE (Blue dial)	Turn to adjust the spacing between the lines or masks.



Adjusting LED Brightness

To adjust the LED reading light brightness, do the following:

1. Press and **hold** the black **ADVANCED** button.
2. Do one of the following:
 - Turn the yellow **BRIGHTNESS** dial  clockwise to increase brightness.
 - Turn the yellow **BRIGHTNESS** dial  counterclockwise to decrease brightness.
3. Release the black **ADVANCED** button when finished.

Saving an Image

To save the live or still image that is displayed on the screen, do the following:

1. Press and **hold** the black **ADVANCED** button, and then the red **FREEZE FRAME** button  until the Save icon  displays.
2. The unit returns to live view, and the image is now saved to the SD Card.

Images are saved in 24-bit BMP format with a resolution of 1280 x 800 pixels.

Images are named and numbered in the order saved, for example, IMG_0001.bmp, IMG_0002.bmp, and so on.

Note: Images can only be saved when an SD Card is in the SD Card slot (1). If the image cannot be saved,  displays on the screen.

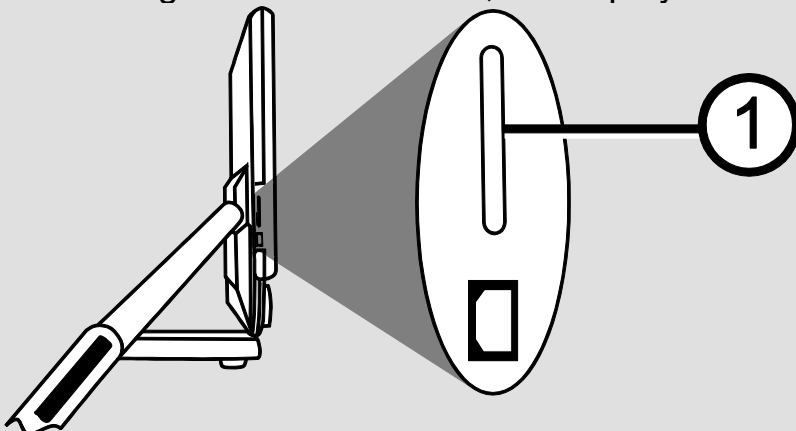

Reviewing or Deleting Images Saved on an SD Card

Note: To enter Review mode from live view or freeze frame, press the red **FREEZE FRAME** button for six seconds.

X displays if an SD Card is not in the SD Card slot. Verify that the SD Card is inserted in the card slot.

After entering Review mode, the latest saved image displays on the screen.

To review other images saved on an SD Card, do the following.

1. Turn the blue **COLOR MODE** dial  to move forward or back through the saved images.
2. The Save Image check box is selected for each image.

To delete the current image while in Review mode,

1. Press and **hold** the black **ADVANCED** button and then press the orange **FIND** button  to clear the check box .

The image is deleted when you exit Review mode.

Note: If you change your mind and decide to save the image, press the **ADVANCED** and **FIND** buttons again to toggle and select the check box **before** exiting Review mode.

2. To delete another image, turn the blue **COLOR MODE** dial  to move forward and back through the saved images, and then repeat step 1 above.
3. Press and **hold** the red **FREEZE FRAME** button  for six seconds to exit and return to live view.

Displaying a Slide Show

You can create a slide show that loops continuously using the images saved on the SD Card. Each image displays for approximately five seconds. The order that images display is based on their file names, for example, IMG_0001.bmp, IMG_0002.bmp, and so on. For best results, all images on the SD Card should have a resolution of 1280 x 800 pixels.

To rearrange the order that images display, you can insert the SD Card into your computer, rename the files (alphanumeric characters) in the order that you like, and then reinsert the SD Card into the unit. (The file names should not be longer than eight characters followed by the BMP file extension.)

Before You Begin

You must be in Review mode before you start a slide show. To enter Review mode, press and **hold** the red **FREEZE FRAME** button  for approximately six seconds.

To start the slide show, do the following:

1. Press and **hold** the black **ADVANCED** button and the red **FREEZE FRAME** button .

The first image stored on the unit, based on its file name, displays on the unit's screen for approximately five seconds followed by the second image, the third, and so on.

2. To stop the slide show and return to Review mode, press the black **ADVANCED** button and the red **FREEZE FRAME** button .

To restart the slide show, press the black **ADVANCED** button and the **FREEZE FRAME** button  again.

3. To stop the slide show and return to live view, press and **hold** the red **FREEZE FRAME** button  for six seconds.

Reading Lines and Reading Masks

Reading lines display as two horizontal or vertical lines on the screen. Reading masks block part of the screen to show only a horizontal or vertical slice of the screen. Use these items to help you maintain your place while reading text. You can also adjust the distance between the lines or the masks that display on the screen.

Turning On Lines or Masks

To select reading lines or mask, do the following:

1. Press and **hold** the black **ADVANCED** button.
2. Turn the black **MAGNIFICATION** dial  to cycle through and select one of the following options: horizontal lines, vertical lines, horizontal masks, vertical masks, or none.

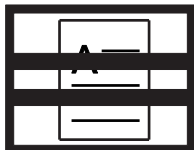

Horizontal
Lines



Vertical
Lines



Horizontal
Masks



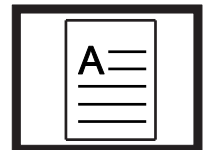

Vertical
Masks



None

Adjusting Distance Between Lines or Masks

To adjust the distance between lines or masks, do the following:





1. With lines or masks displayed on the screen, press and **hold** the black **ADVANCED** button.
2. Do one of the following:
 - Turn the blue **COLOR MODE** dial  clockwise to increase the distance between lines or masks
 - Turn the blue **COLOR MODE** dial  counterclockwise to decrease the distance between lines or masks
3. When finished, release the black **ADVANCED** button.

Adding and Removing Color Modes

The unit has six default color modes that are available as you turn the blue **COLOR MODE** dial . You can have up to 12 color modes enabled at one time.

Using the Configuration menu, there are an additional 27 different color combinations that you can choose from. For a list of color modes, see *Color Modes* on page 22.

To add or remove color modes, do the following:

1. Press and **hold** the black **ADVANCED** button and the orange **FIND** button  for approximately 10 seconds to enter the Configuration menu.
2. Turn the blue **COLOR MODE** dial  to view the different color combinations.
 -  indicates that the color mode is enabled
 -  indicates that the color mode is disabled
3. Press the red **FREEZE FRAME** button  to toggle between enabling and disabling the current color mode displayed on the screen.

Note: The first three color modes, True Full Color, White on Black, and Black on White, are always available and cannot be disabled.

4. Repeat steps 2 and 3 to continue adding or removing color modes.

You can have a maximum of 12, or a minimum of three available color modes.

5. When you are finished, press and **hold** the black **ADVANCED** button and orange **FIND** buttons  again for approximately 10 seconds to save changes and exit Configuration mode.

Restoring Factory Settings

Press and **hold** the following buttons for approximately 10 seconds to reset the unit to its default settings. Release the buttons when the unit restarts.

- Black **ADVANCED** button
- Red **FREEZE FRAME** button
- Orange **FIND** button

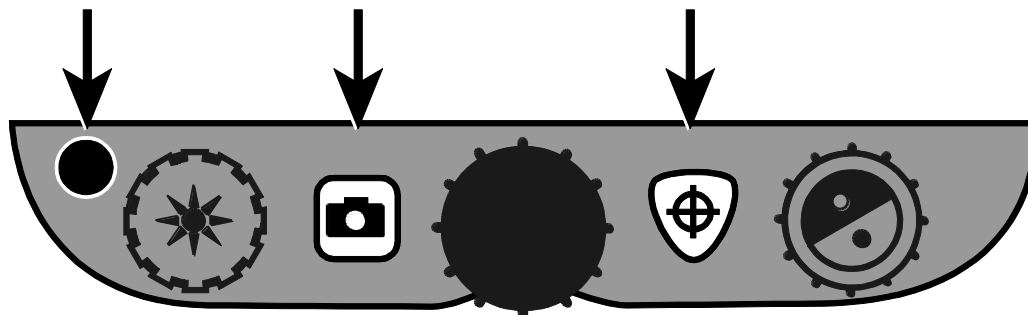

Appendix A - Color Modes

There are six factory default color modes and 27 additional color modes that you can activate and use. Select the color modes that best suit your visual needs, for example, yellow text against a black background.

- | | | |
|--|--------------------|---------------------|
| 1. Full Color ¹ | 12. White on Blue | 23. Red on Black |
| 2. Black on White ¹
(high-contrast positive) | 13. Blue on White | 24. Violet on White |
| 3. White on Black ¹
(high-contrast negative) | 14. Green on Black | 25. White on Violet |
| 4. Yellow on Blue ² | 15. Black on Green | 26. Orange on Black |
| 5. Yellow on Black ² | 16. Red on White | 27. Black on Orange |
| 6. High-Contrast Full Color ³ | 17. White on Red | 28. Green on Yellow |
| 7. Grayscale | 18. White on Green | 29. Yellow on Green |
| 8. Blue on Yellow | 19. Green on White | 30. Amber on White |
| 9. Black on Yellow | 20. Black on Blue | 31. White on Amber |
| 10. Violet on Black | 21. Blue on Black | 32. Black on Amber |
| 11. Black on Violet | 22. Black on Red | 33. Amber on Black |

¹ Default color modes for positions 1 through 3; cannot be changed or deleted.

² Default color modes for positions 4 and 5; can be changed or deleted. A maximum of 12 positions can be active.



³ Default color mode.

Appendix B - Changing and Saving Settings

You can change the unit's factory settings using the Configuration menu as described in this section.

Note: When configuring color modes, it is best to have both a page of text and a color photo to place under the camera to select settings best suited for you.



1. Press and **hold** the black **ADVANCED** button and the orange **FIND** button  for approximately 10 seconds to open the Configuration menu. Release the buttons when the firmware version number displays.

The color mode setting displays on the screen: the color mode icon ( or ) a check mark or X to indicate if the color mode is enabled or disabled, and the position number.



Color modes for positions 1 through 3 cannot be changed or deleted. For a list of available colors, refer to *Color Modes* on page 22.

2. Turn the blue **COLOR MODE** dial  to scroll through positions 4 through 12.

To select and enable () a position:







- Press the red **FREEZE FRAME** button .
- The color combination currently displayed on the screen is assigned to that position number.
- If you press the button again, the position is cleared () and disabled.

To select a position (4 through 12) and a color mode:

- Turn the yellow **BRIGHTNESS** dial  to view the 33 color modes.
- When you find a color mode that you want to use, press the red **FREEZE FRAME** button  to select () the color combination and enable the current position.

Repeat this step as necessary to configure other positions.



3. Press the black **ADVANCED** button to move to subsequent options. Below are descriptions for these options.

Icon	Description	Default Setting
	Freeze Frame	✓
	Find	✓
	Magnification Tables ¹	1
	Magnification Display Number ¹	"88"
	Time ²	00:00 (HH:MM in 24-hour format)
	Date ²	01.01.14 (MM.DD.YY)
	Auto Power-Down ³	✓

¹ See *Adjusting Magnification Settings* on page 25 for more information.

² Time and Date settings are only saved while a battery is installed and charged. For more information, see *Changing the Battery* on page 31.

³ Only applies when running on battery power.

4. When an item that you want to change displays, press the red **FREEZE FRAME** button  to cycle through the different settings available for that option.
5. When finished, press and **hold** the black **ADVANCED** button and the orange **FIND** button  again for at least 10 seconds to save and exit the Configuration menu.

Note: To restore factory default settings, refer to page 21 for more information.

Appendix C - Adjusting Magnification Settings

Note: The following is an advanced feature and is accessed while in Configuration mode.

There are three magnification tables from which you can choose the best magnification configuration for your vision needs.

- **Table 1** is ideal if you are comfortable with lower magnification. It provides finer adjustments between positions 1 through 5.

(Turn the black **MAGNIFICATION** dial  to step through positions 1 through 16.)

- **Table 2** is the default magnification table and is ideal for most users.
- **Table 3** provides finer adjustments for high-end magnification available between positions 6 through 10. This table is good if you need greater magnification.

Note: Tables 1 and 3 have a higher top-end magnification range. This results in some loss of resolution when using Full Color mode.



To read comfortably above 24x, choose a contrasting color mode, for example, white text on a black background.

Experiment with the different magnification tables and use the one that is best for you. You can always revert to table 2 at any time if you are not comfortable with the magnification available in tables 1 and 3. The following describes how to select and edit your viewing preferences.

Selecting a Magnification Table

1. Press and **hold** the black **ADVANCED** button and the orange **FIND** button  for approximately 10 seconds to open the Configuration menu.
2. Continue to press the black **ADVANCED** button until the video magnification icon displays on the screen.

AAA

3. Press the red **FREEZE FRAME** button  to select one of the three magnification tables. For an overview of magnification tables, refer to the table descriptions mentioned earlier.
4. Do one of the following:
 - To save the change and exit Configuration mode, press and **hold** the black **ADVANCED** button and then the orange **FIND** button  for approximately 10 seconds until the on-screen display at the bottom of the screen turns off.
 - To customize how magnification values display on the screen, perform the steps in the next section.

Changing the Magnification Display Number

After selecting a magnification table, you can choose whether or not the current magnification value displays on the screen as you turn the black

MAGNIFICATION dial . To set your preference, do the following:

1. Press the black **ADVANCED** button until the magnifying glass icon displays on the screen.
2. Press the red **FREEZE FRAME** button  to select how magnification values display. This is represented by the magnifying glass icon.



Select to display the magnification in use relative to the 16 positions of the black **MAGNIFICATION** dial, for example, 1, 2, 3,...14, 15, 16.



Select if you do not want any magnification value to display as you turn the black **MAGNIFICATION** dial.



Select to display the actual magnification value, for example, 3.7, 6.4, 13, and so on.





3. To save changes and exit Configuration mode, press and hold the black **ADVANCED** button and the orange **FIND** button  for approximately 10 seconds until the on-screen display at the bottom of the screen closes.

To discard all changes made while Configuration mode is open, do not touch any control panel buttons or dials for approximately 30 seconds. This closes Configuration mode without saving changes.

Appendix D - Configuration Menu Settings

Setting	Description
<p>Color Select</p> <div style="display: flex; justify-content: space-around; align-items: center; margin-top: 20px;"> T T </div>	<p>Adds more color positions so that additional color combinations are available when you turn the blue COLOR MODE dial during normal operation.</p> <p>By default, positions 1 through 5 are available. Positions 6 through 12 can be added using this setting.</p> <p>Hollow icon - T</p> <p>Positions 1 through 3 are always available and cannot be changed.</p> <p>Position 1 is always full color. Position 2 is black on white (high-contrast positive). Position 3 is white on black (high-contrast negative).</p> <p>Solid icon - T</p> <p>Displays for positions 4 through 12. These positions can be added to or removed from normal operation. In addition, you can select one of 33 different color combinations for each position.</p> <p>By default, position 4 is yellow on blue, and position 5 is yellow on black. Both positions can be changed using this setting.</p> <p>Adding and removing Color Modes</p> <p>To add a position, select (✓) it by pressing the red FREEZE FRAME button. To remove a position, clear (✗) it by pressing the red FREEZE FRAME button.</p>

Setting	Description
<p>Freeze Frame</p> <p> </p>	<p>Disables or enables freeze frame functionality. It is enabled (✓) by default.</p> <p>If you disable (✗) it, Freeze Frame is no longer available when you press the red FREEZE FRAME button during normal operation.</p>
<p>Find</p> <p>+</p>	<p>During normal operation, Find displays a set of crosshairs on the screen and zooms out so that you can see more of the item displayed on the screen.</p> <p>This setting is enabled (✓) by default. If you disable (✗) it, Find is no longer available when you press the orange FIND button during normal operation.</p>
<p>Magnification Levels</p> <p>AAA</p> <div data-bbox="204 1335 587 1831" style="border: 2px solid black; padding: 5px;"> <p>Note: Tables 1 and 3 have a higher top-end magnification range.</p> <p>This results in some loss of resolution when using Full Color mode.</p> <p>To read comfortably above 24x, choose a contrasting color mode, for example, white text on a black background.</p> </div>	<p>The unit can display 16 levels of magnification when you turn the black MAGNIFICATION dial (positions 1 to 16).</p> <p>Three separate magnification tables are available for use. Each table offers slightly different values so that you can choose the best magnification power for you.</p> <p>Table 1 is best if you are comfortable with lower magnification. It provides finer adjustments between positions 1 to 5.</p> <p>Table 2 is the default magnification table and is ideal for most users</p> <p>Table 3 provides finer adjustments in the middle magnification range available between positions 6 to 10. This table is good if you need greater magnification.</p> <p>Press the red FREEZE FRAME button to select table 1, 2, or 3.</p>

Setting	Description
<p data-bbox="251 233 521 310">Magnification Display Number</p> 	<p data-bbox="659 233 1390 401">Sets the type of magnification value that displays on the screen as you turn the black MAGNIFICATION dial. Press the red FREEZE FRAME button to select a value.</p> <p data-bbox="659 436 1373 562">Select the icon with “88” to display the magnification in use relative to the 16 dial positions, for example, 1, 2, 3,...14, 15, 16.</p> <p data-bbox="659 632 1365 800">Select the icon with the clear magnifying glass if you do not want to see a magnification value display as you turn the dial.</p> <p data-bbox="659 835 1414 961">Select the icon with “X” to display the actual magnification value, for example, 3.7, 6.4, 13, and so on.</p>
<p data-bbox="375 1031 459 1066">Time</p> 	<p data-bbox="659 1031 1414 1199">Sets the time in 24-hour format (HH:MM). Image file names are based on the unit’s time and date. The time setting is persistent as long as a battery is installed and charged.</p>
<p data-bbox="378 1266 456 1302">Date</p> 	<p data-bbox="659 1266 1406 1434">Sets the date (MM.DD.YY). Image file names are based on the unit’s time and date. The date setting is persistent as long as a battery is installed and charged.</p>
<p data-bbox="267 1514 570 1549">Auto Power-Down</p> 	<p data-bbox="659 1509 1406 1635">When running on battery power only, the unit powers off automatically after 30 minutes of inactivity. This extends battery life.</p> <p data-bbox="659 1650 1414 1776">If you like, you can disable (✘) this setting so that the unit does not power off automatically when running on battery power.</p> <p data-bbox="659 1791 1398 1917">If the unit is connected to AC power, it will continue to run after 30 minutes whether this setting is enabled or disabled.</p>

Appendix E - Changing the Battery

A Li-ion battery is an optional feature. Contact Freedom Scientific if you later wish to purchase a battery.

To remove a battery and replace it with a charged battery, do the following:

Removing the Battery

1. Power off and unplug the unit.
2. Open the unit as described earlier in *Setting Up the Unit* on page 3.
3. Carefully lay the unit on its back with the monitor hanging over the edge of a table, desk, or other sturdy surface.

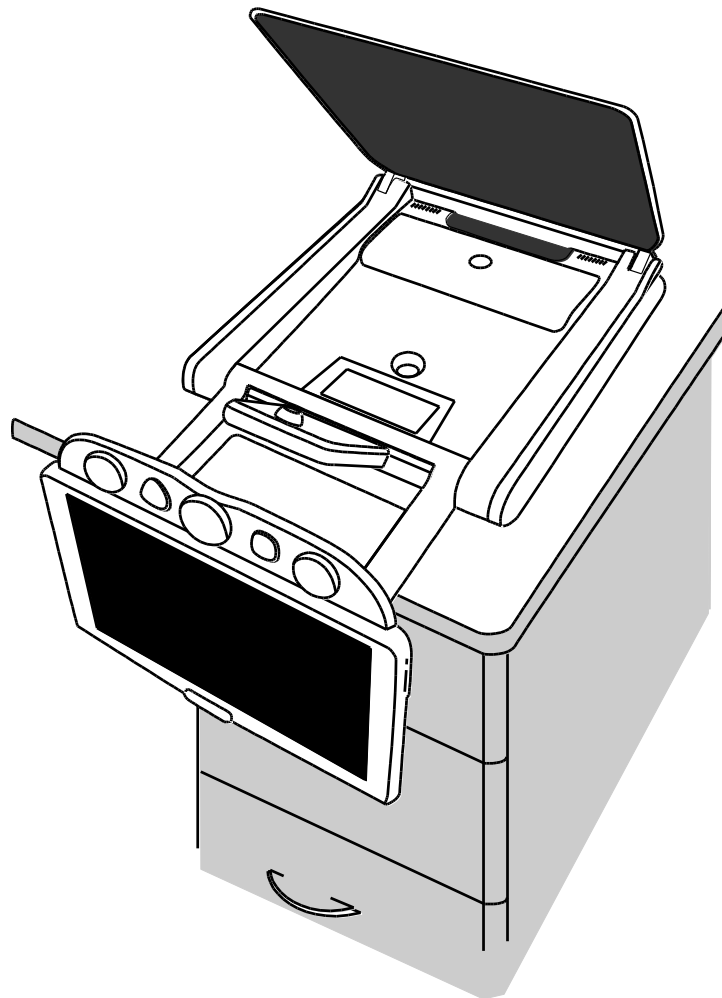

4. Use both thumbs to press down on the outside edges of the battery compartment door, and then slide it toward you.

This releases the battery door and exposes the battery.

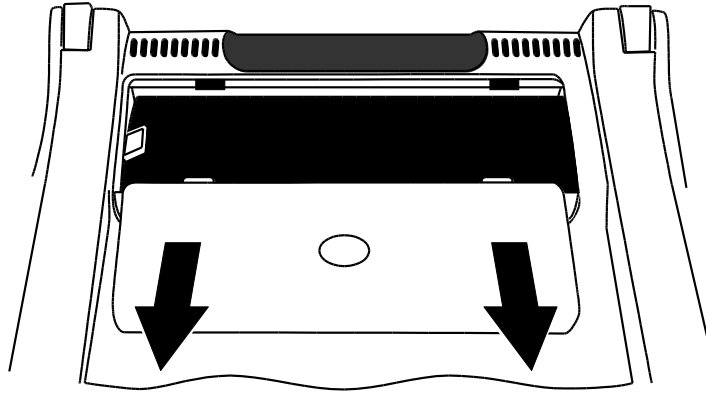

5. Use the plastic tab (1) located on the left side of the battery to lift and remove the battery.

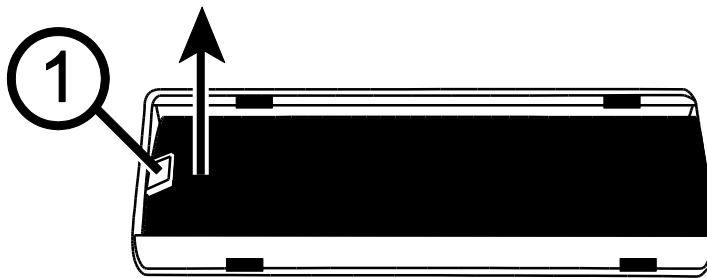

Replacing the Battery

1. Place the battery into the compartment. Make sure that the battery's contacts align with the compartment's contacts.

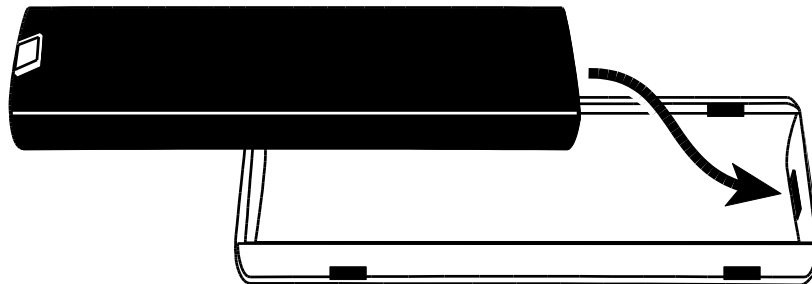

2. Align the battery door's locking tabs with the compartment's slots, and slide the door until it locks. Make sure that the battery's plastic tab remains inside the compartment.

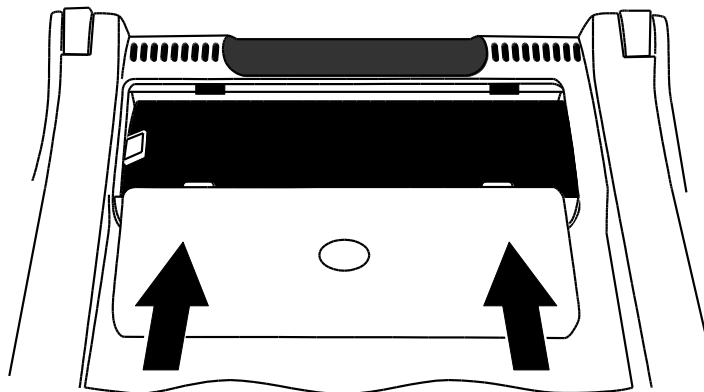

3. Place the unit right-side up on the table, and then power on the unit. The battery status icon displays on the screen.

Setting Date and Time





After replacing the battery, you must reset the unit's date and time so that saved images have an accurate timestamp.

1. Press and **hold** the black **ADVANCED** button and the orange **FIND** button  for approximately 10 seconds to enter Configuration mode. Release the buttons when the version number displays.
2. Press and release the black **ADVANCED** button until the clock option displays on the screen. The format is HH:MM (24-hour).

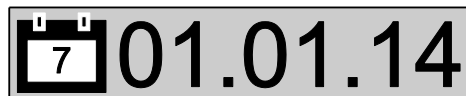

- Turn the yellow **BRIGHTNESS** dial  to adjust the hour.
 - Press the red **FREEZE FRAME** button  to move to minutes, and then turn the yellow **BRIGHTNESS** dial  to set minutes
3. Press the black **ADVANCED** button to display the date option. The format is MM.DD.YY.



- Turn the yellow **BRIGHTNESS** dial  to adjust the month
 - Press the red **FREEZE FRAME** button  to move to day, and then turn the yellow **BRIGHTNESS** dial  to set the day
 - Press the red **FREEZE FRAME** button  again, and turn the yellow **BRIGHTNESS** dial to set the year. The year format is the last two digits of the current year.
4. When finished, press and **hold** the black **ADVANCED** button and the orange **FIND** button  for at least 10 seconds to save and exit the Configuration menu.

Appendix F - Troubleshooting

Problem	Solution
The screen is blank.	<p>Press the unit's power button.</p> <p>Make sure the power cable is correctly connected to the unit and a power outlet.</p> <p>Reduce magnification.</p> <p>Try adjusting brightness.</p> <p>Switch to a different color mode.</p> <p>When running on battery power only, the unit powers off automatically after 30 minutes of inactivity. This extends battery life.</p>
The unit does not power on.	<p>Press the unit's power button.</p> <p>When using the power cord, ensure that the power outlets have power and are not malfunctioning. If the outlets are connected to a wall switch, make sure that the switch is on.</p>
The image on the screen is not changing.	Exit Review mode and return to live view by pressing the red Freeze Frame button.
The unit is not responding.	Press and hold the unit's Power button for at least 12 seconds to reboot the unit.
The image on the screen is too bright, or there is a glare from the screen that makes it difficult to see.	<p>Reduce brightness.</p> <p>Switch to a different color mode.</p>
The image on the screen is too dark.	<p>Increase brightness.</p> <p>Switch to a different color mode.</p>

Problem	Solution
There are smudges or blemishes on the screen.	Clean the screen using a damp, soft, lint-free cloth.
Self-view camera does not display an image.	Make sure the camera cover is open.
The unit does not power off automatically after 30 minutes.	If a battery is installed in the unit, verify that the Auto Power-Down setting is enabled in the Configuration menu. If the unit is connected to AC power, it will continue to run and not power off automatically.

Appendix G - Service and Support

You can contact Freedom Scientific Technical Support to receive technical assistance. Before contacting Technical Support, it is recommended that you refer to *Troubleshooting* on page 35 to try to resolve your problem quickly.

Note: This device has no user-serviceable components. Any unauthorized attempt to service or replace internal components will void the product warranty.

To contact Technical Support by Web, visit **www.FreedomScientific.com**, choose Support, and complete the form to submit questions.

To contact by e-mail, send questions to **Support@FreedomScientific.com**.

To contact by telephone, U.S. customers can call **(727) 803-8600**, Monday through Friday, from 8:30 AM to 7:00 PM (Eastern Time).

When you call, please have your questions ready and be prepared to provide the following information:

- Product name
- Product serial number
- What you were doing when the problem occurred
- How you tried to solve the problem

To register your product, visit **www.freedomscientific.com/forms/ProductRegistration**.

Federal Communications Commission (FCC) Compliance Statement

This device complies with Part 15 of the FCC Rules. Operation is subject to the following two conditions: (1) this device may not cause harmful interference, and (2) this device must accept any interference received, including interference that may cause undesired operation.

This equipment has been tested and found to comply with the limits for a Class B digital device, pursuant to Part 15 of the FCC Rules. These limits are designed to provide reasonable protection against harmful interference in a residential installation. This equipment generates, uses, and can radiate radio frequency energy and, if not installed and used in accordance with the instructions, may cause harmful interference to radio communications. However, there is no guarantee that interference will not occur in a particular installation. If this equipment does cause harmful interference to radio or television reception, which can be determined by turning the equipment off and on, the user is encouraged to try to correct the interference by one or more of the following measures:

- Reorient or relocate the receiving antenna
- Increase the separation between the equipment and receiver
- Connect the equipment into an outlet on a circuit different from that to which the receiver is connected
- Consult the dealer or an experienced radio or television technician for help

CAUTION: Changes or modifications not expressly approved by the party responsible for compliance could void the user's authority to operate the equipment.

Regulatory Compliance

RG-2: **CAUTION:** Do not stare at exposed lamp in operation. May be harmful to the eyes.